

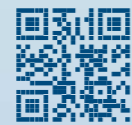

CATÁLOGO GENERAL 2014



[www.marti1921.com](http://www.marti1921.com)

# CATÁLOGO GENERAL 2014

GENERAL CATALOGUE | CATALOGUE GÉNÉRAL  
GENERAL KATALOG | ГЕНЕРАЛЬНЫЙ КАТАЛОГ

*Martí*  
1921  
barcelona



*Martí*  
1921

*Martí*  
1921  
barcelona



Les presentamos la edición 2014 de nuestro catálogo. 2014 supone añadir un año más de experiencia. Por si solo encierra tanto espíritu de superación que sobran más palabras.

Muchas gracias por su confianza

*We present you the 2014 edition of our catalogue. 2014 means one more year of experience for us. By itself, it contains so much spirit and improvement, that the words spare.*

*Thank you very much for trusting us*

*Nous présentons l'édition 2014 de notre catalogue. 2014 signifie l'ajout d'un an plus d'expérience. Par lui-même contient tellement esprit de dépassement, que plusieurs mots restent.*

*Merci beaucoup pour votre confiance*

Carlos Martí

# Índice

PRODUCT GUIDE



**4**

93 AÑOS DE HISTORIA

**6**

ECOEFICIENCIA SEGURIDAD Y CONFORT

**8**

PRESENCIA INTERNACIONAL

**12**

COCINAS

**32** Algora

**38** AMS

**44** AMS Play

**50** Carlo

**58** Cubic

**64** Rebel

**70** Rodano

**76** The One

**82** Willy

**88** O<sup>2</sup>

**92** Ice

**98** Época

**102** Sena

**108** Madrid

**114** Arte

**120** CC1

**126** Granada

**132** On

**138** Aktiva

**144** Rialto

**150** París

**154** Temporizados

**158** Electrónicos

**162**

TERMOSTÁTICOS

**170**

SETS

**178**

HOTELES Y COLECTIVIDADES

**202**

COMPLEMENTOS Y RECAMBIOS

**230**

SHOWROOM & EXPOSITORES

**234**

CONDICIONES DE VENTA

# 93 años de historia

93 YEARS HISTORY



## BARCELONA 1921-2014

MARTÍ 1921 inicia su actividad en 1921 en Barcelona en un pequeño taller de la calle Riereta como fabricante de sus propios mecanismos de grifería, especializado en productos para lavabo y cocina, grupos de baño-ducha con una gran versatilidad para personalizar las salas de baño, sets de baño, termostáticos, columnas de baño y complementos.

Tras investigar y diseñar nuevos sistemas de producción, y siendo pionero en la fabricación de monomandos y desarrollo de métodos de ahorro de agua y energía, pronto se convierte en un referente en el sector en la economía de agua y energía, velando por el medio ambiente (ISO 14001 e ISO9001), y por sus líneas de diseño que marcan tendencia.

Con una sólida proyección internacional, MARTÍ 1921 está presente en más de 60 países, con nuevas líneas de grifería para todo tipo de proyectos, piezas exclusivas que combinan ingeniería, artesanía, belleza y distinción, y productos que responden a los nuevos retos que se nos plantean, como el medio ambiente, la sostenibilidad, seguridad, eficiencia, fiabilidad e innovación; con la finalidad de cumplir su compromiso con la sociedad y con sus clientes.

Nuestro mayor patrimonio es el esfuerzo continuo de empleados, clientes y delegados, todos ellos implicados, como no podía ser de otra forma, en unos objetivos comunes; alcanzar la excelencia en unos productos cada día más innovadores, de mejor diseño, más duraderos y, ante todo, respetuosos con el medio ambiente.

## BARCELONA 1921-2014

*Martí 1921 started its activity in 1921 in Barcelona, in a small workshop, on Riereta street, as manufacturer of its own faucets mechanism, specialized in products for basins and kitchen, groups of bath- shower, with a great versatility of personalizing bathrooms, sets for baths, thermostatic, bath columns and complements.*

*After researching and designing new systems of production, and being a pioneer of the faucets manufacturing and developing methods for water and energy savings, soon turns into a leader in the sector, taking care of the environment (ISO 14001 and ISO 9001) and of its trend setting lines.*

*With a strong international projection, MARTÍ 1921 is present in more than 60 countries, with new lines of mixers for all type of projects, exclusive pieces that combine engineering, handcrafting, beauty and distinction, and products that face the new challenges, as the environmental care, sustainability, safe, efficiency, reliability and innovation; with the final purpose of fulfilling its commitment with the society and the clients.*

*Our major heritage is the constant effort of employees, clients and delegates all of them implied, since it could not be of another form, in accomplishing common aims: reaching the excellence in products that are more innovators every day, with better design, more lasting and, above all, respectful with the environment.*

# Ecoeficiencia, seguridad y confort

ECO-EFFICIENCY, SAFETY AND CONFORT

MARTÍ 1921 lleva más de 90 años perfeccionando sus productos para atender las nuevas exigencias del mercado, integrando en la gran mayoría de sus mecanismos innovadores sistemas de ecoeficiencia, termostáticos, seguridad, ahorro de agua y energía, limitadores de caudal, ergonomía y cromoterapia, que han posicionado su producto con una buena relación calidad-diseño-precio, servicio y garantía.

En la actualidad, MARTÍ 1921 centra sus esfuerzos en desarrollar sistemas **ECOEFICIENTES** para limitar el consumo de agua y energía, sin perjudicar el confort del cliente.

La **SEGURIDAD** de nuestras griferías forma parte de nuestra responsabilidad y compromiso con la sociedad.

*Martí 1921 has more than 90 years, perfecting its products, in order to attend the new market demands, integrating in most of its mechanisms, innovating systems of eco-efficiency, thermostatics, safety, water savings and energy, flow limiters, ergonomics and chromotherapy, which have positioned their product with a good design- price relation, as well as service- warranty.*

*Currently, MARTI 1921 focuses its efforts on developing **ECO-EFFICIENT** systems to limit water and energy consumption without compromising client comfort.*

**SAFETY** of our faucets is part of our responsibility and commitment to society.



## ECOSYSTEM / ECOSYSTEM

Resistencia en el recorrido de la palanca del grifo monomando para suministrar el 50% del caudal. Incorpora un sencillo dispositivo de dos posiciones en la palanca que permite diferenciar entre la zona de caudal económico y caudal máximo. Al levantar la palanca para obtener más caudal, un tope elástico ofrece una ligera resistencia y advierte que se pasa a la zona de máximo caudal logrando así un ahorro de agua. El usuario puede superar esta limitación abriendo el grifo a su caudal máximo. Viene montado desde fábrica y no requiere ningún mantenimiento. (Opcional)

*Resistance in the path of the mixer tap lever, to supply 50% of the flow rate. It incorporates a simple device of two positions on the lever that allow to differentiate between the economic flow range and the maximum flow. By lifting the lever for more flow, an elastic top offers a slight resistance and warns that passes near maximum flow, this way achieving water savings. The user can overcome this limitation by opening the faucet to its maximum flow. It comes installed from factory and requires no maintenance. (Optional)*



## LIMITACIÓN DE TEMPERATURA / TEMPERATURE LIMITATION

Sistema limitador de temperatura del agua caliente que indica al usuario el límite de temperatura de uso eficiente (38-42°C), consiguiendo así un ahorro energético y evitando quemaduras.

*A temperature limitation system for the hot water, that indicates the user the limit of the temperature, for an efficient use (38- 42°C), achieving energy savings, and avoiding burnings.*



## LIMITACIÓN DE CAUDAL / LIMITATION OF THE WATER FLOW

Sistemas de limitación de caudal de forma eficiente que permiten reducir el consumo de agua manteniendo el confort de uso. Los aireadores mezclan aire y agua para reducir el consumo de agua y evitar salpicaduras. MARTÍ 1921 desde 1995 innovando y aplicando soluciones ecoeficientes.

*Flow limitation systems that reduce water consumption, while maintaining wearing comfort. The aerators mix air and water in order to reduce water consumption and avoid splashing. Since 1995, Martí 1921 has been innovating and applying efficient solutions.*



## SENSIBILIDAD / SENSITIVITY

Nuestros cartuchos de monomando y termostáticos permiten regular cómodamente la temperatura deseada.

*Our single- handle mixer and the thermostatic ones, allow the easy adjust of the desired temperature.*



## BLOQUEO DE SEGURIDAD / TERMOSTOP BLOCK

Dispositivo que permite limitar la temperatura de agua caliente (<38°C) según el nivel de seguridad deseado bloqueando el recorrido de la palanca del monomando. Evita el riesgo de quemaduras así como el consumo excesivo de agua caliente. El usuario debe pulsar el botón y girar el volante para obtener temperaturas superiores. (Opcional)

*Device that allows the blocking of the hot water temperature (<38°C), according to the desired security level, by blocking the circuit of the handle. It avoids the burning risks, as well as the excessive use of hot water. The user must press the button and move the lever, in order to get higher temperatures. (Optional)*



## SANITARIA/MÉDICA / SANITARY/ MEDICAL

Toda la grifería MARTÍ 1921 supera las exigencias normativas sanitarias de KTW (Alemania), WRAS (Reino Unido) y ACS (Francia), que garantizan que los materiales en contacto con el agua no suponen ningún riesgo para la salud.

*All MARTI mixers exceed regulatory requirements of health KTW (Germany), WRAS (UK) and ACS (France), that ensure that the materials in contact with water pose no risk for the health.*



## ANTILEGIONELA / ANTELEGIONELA

MARTÍ 1921 dispone de diversos sistemas que previenen la proliferación de la legionela.

*Martí disposes of different systems that prevent the growth of the Legionella.*



## CROMOTERAPIA / CHROMOTHERAPY

La cromoterapia es un método de armonización y ayuda natural al equilibrio del cuerpo y la mente por medio de los colores en nuestra ducha diaria.

*The chromotherapy is a way of harmonizing the balance of the body and mind, by using colors, in our everyday shower.*



## REDUCCIÓN DE SONIDO / SOUND REDUCTION

Las griferías MARTÍ 1921 disponen de varios sistemas de protección acústica que permiten superar la normativa europea que exige no sobrepasar los 30dB. Nuestras excéntricas de conexión van equipadas con un elemento reductor de ruido (silenciador), al igual que los cartuchos cerámicos. Disponemos de diferentes filtros acústicos tanto en las entradas de agua de los grifos como en el interior de sus mecanismos de regulación. (Opcionales)

*Martí mixers dispose of several systems of acoustic protection, that allow overcome the European norms, that require not to exceed the limit of 30Db. Our connection cams, as well as the ceramic cartridges, are equipped with noise reducing element (silencer). We have different acoustic filters, both at the water inputs, and inside of their regulatory system. (Optional)*



## DURABILIDAD Y ROBUSTEZ / DURABILITY AND STRENGTH

Los productos MARTI 1921 están avalados por un siglo de experiencia industrial. Técnicamente innovadores en soluciones técnicas y diseño, aportan además gran robustez para soportar todo tipo de uso, incluso el más intensivo. Gracias a unos exigentes procedimientos certificados ISO 9001/2008 podemos garantizar el completo proceso de fabricación y la fiabilidad que aportan para su uso público.

Para certificar la calidad del acabado se realizan pruebas en cámaras de niebla salina, superando la norma EN 817. MARTI 1921, en base a los continuos estudios realizados en conjunto con la firma KH LLOREDA y los laboratorios especializados en investigación metalúrgica, certifica que la calidad de sus recubrimientos galvánicos es óptima.

De los análisis realizados en conjunto con KH LLOREDA, MARTI 1921 recomienda el uso de los productos de esta firma, KH7 Antical y ZAS! Baños, para el mantenimiento de sus acabados.

*The MARTI 1921 products are backed up by a century of industrial experience. Technically innovative in technical solutions and design, also provide great strength to withstand all types of use, including the most intensives. Thanks to one of the most demanding procedures certified by ISO 9001/2008, we can guarantee the entire manufacturing process and reliability provided for public use.*

*To certify the quality of the coatings, the tests are performed in salt spray chambers, exceeding EN 817. MARTI 1921. In base of the ongoing studies realized along with the KH LLOREDA company and laboratories specialized in metallurgical research, certifies that the quality of their galvanic coatings is optimal.*

*After the analyzes performed along with KH LLOREDA, MARTI 1921 recommends the use of their the products, KH7 Antical y ZAS! Baños, for the maintenance of their coatings.*

# Presencia Internacional

PROJECTION WORLDWIDE

La internacionalización ha sido y es vocación genética. Con presencia en los 5 continentes, abastecemos las necesidades propias de cada mercado. Martí 1921 utiliza sus fábricas situadas en España, Showrooms en Madrid, Barcelona y París para asegurar el mejor servicio.

*The internationalization has been and still is genetic vocation. With a presence across 5 continents, we supply the needed characteristics of each market. Martí 1921 uses its factories in Spain, Showrooms in Madrid, Barcelona and Paris, in order to ensure the best service.*

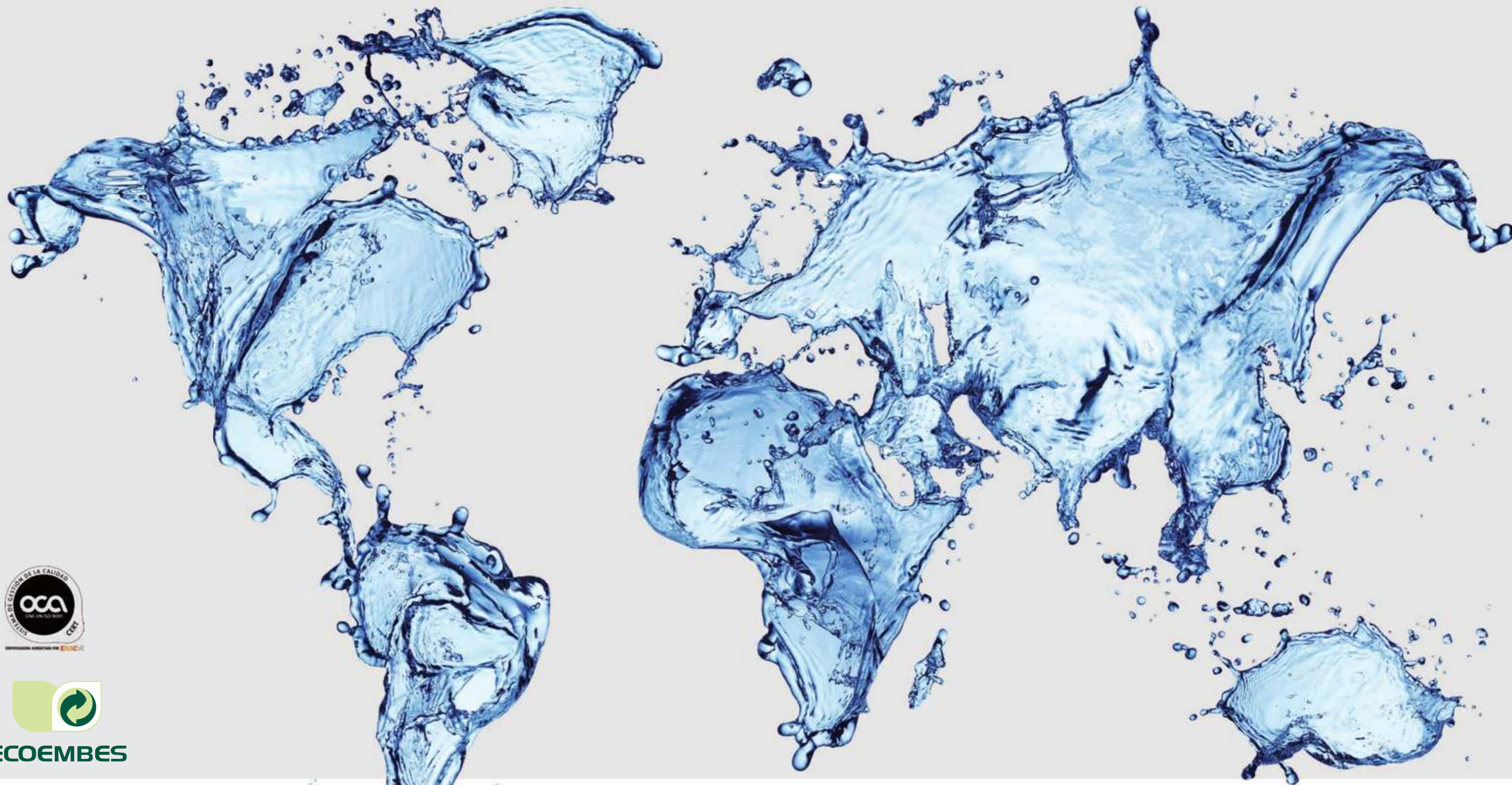

# Glosario de colores y materiales

GLOSSARY OF COLORS AND MATERIALS

 CROMO - CR

Chrome - Chrome - Crom - Хром

 ORO - OR

Gold - Or - Gold - Золото

 ORO MATE - OM

Mate Gold - Or Mat - Mattgold - Матовое золото

 BRONCE - BR

Bronze - Bronze - Bronze - Бронза

 RÚSTICO - RU

Rustic - Rustique - Rustic - Рустик «под старину»

 BLANCO - BL

White - Blanc - weiß - Белый

 BLANCO PERLA METALIZADO - BP

Pearl - Perle - Perle - Жемчужный

 NEGRO - NE

Black - Noir - Schwarz - Черный

 NEGRO PERLA METALIZADO - NP

Black pearl - Perle noir - Schwarze perle - черный жемчуг

 MALVA - CL

Purple - Violet - Violett - Лиловый

 PLATA - PL

Silver - Argent - Silber - Серебро

 ROJO - CR

Red - Rouge - Rot - Красный

 NARANJA - NA

Orange - Оранжевый

 PISTACHO - CP

Green - Vert - Grün - Фисташковый

 CHOCOLATE - CH

Brown - Brun - Braun - Шоколадный

 AZUL - CA

Blue - Bleu - Blau - Синий

 SAFARI - SA

Safari - Леопардовый

 ARCO IRIS - CF

Rainbow - Arc en ciel - Regenbogen - Радуга

 COBRE - CO

Copper - Cuivre - Kupfer - Медь

**c/v** VÁLVULA CLIC CLAC

Click clac valve - Vidage clic clac - Klick klack Ventil - донный клапан

**c/d** VÁLVULA DE DESAGÜE

Pop-up waste - Vidage avec tirette - Ablassventil - сливной клапан

# COCINAS

Exclusivo



*Martí*  
1921  
barcelona



# COCINAS | Sobre repisa

## MRT 2 Monomando fregadero

Sink mixer | Mitigeur évier | смеситель для мойки

Ref.

Color

VI6610

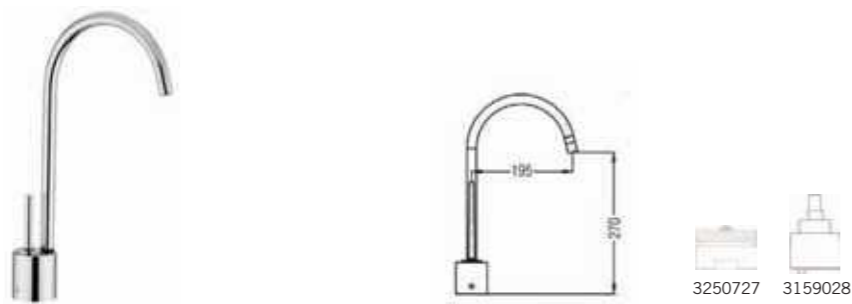

## DF Monomando fregadero

Sink mixer | Mitigeur évier | смеситель для мойки

**NEW**

Ref.

Color

VI4026



## ORIENT Monomando fregadero con salida rótula orientable

Sink mixer | Mitigeur évier | смеситель для мойки

Ref.

Color

VI4001

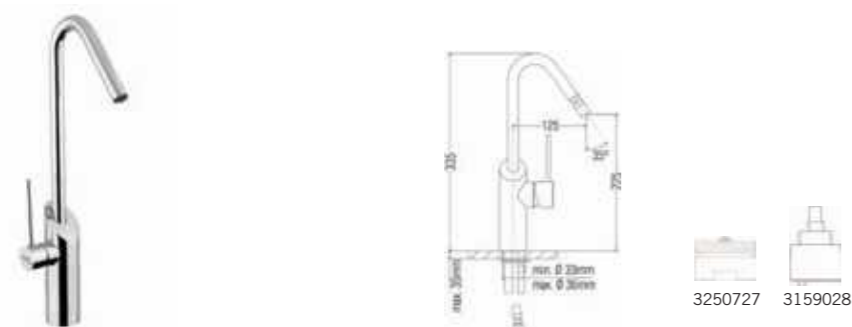

## MN Monomando fregadero

Sink mixer | Mitigeur évier | смеситель для мойки

**NEW**

Ref.

Color

VI4027



## AB Monomando fregadero

Sink mixer | Mitigeur évier | смеситель для мойки

**NEW**

Ref.

Color

VI4028

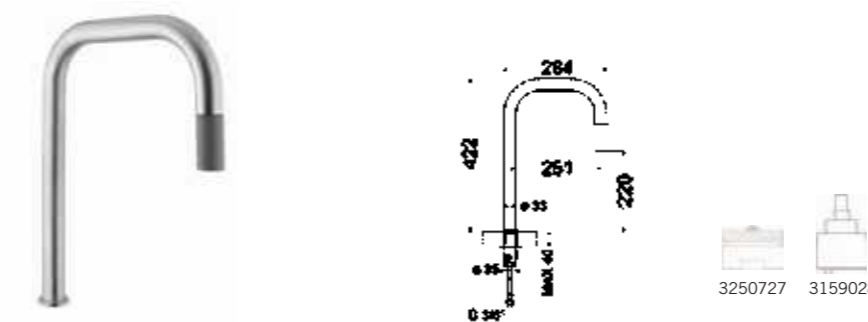

## BC Monomando fregadero

Sink mixer | Mitigeur évier | смеситель для мойки

**NEW**

Ref.

Color

VI4029

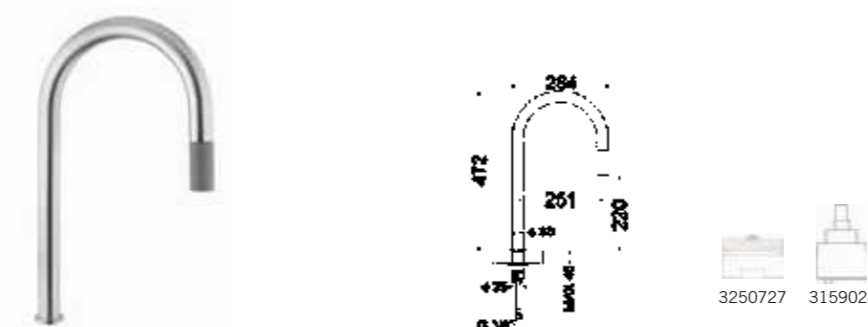

## 1921 RETRO CARABELA Bimando fregadero

Sink mixer | Mélangeur évier | Spültischbatterie | смеситель для мойки

Ref.

Color

315026

315026BR

315026RU

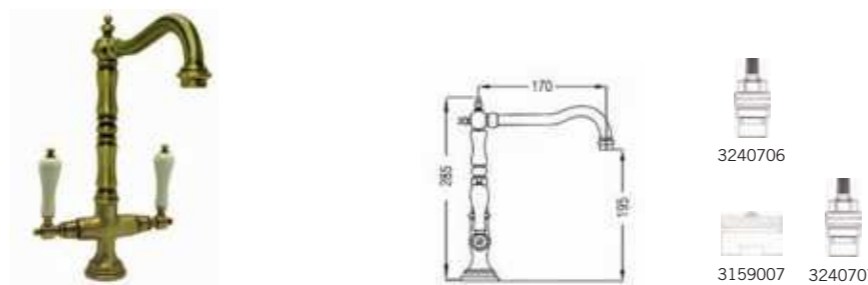

## 1921 RETRO MAJESTIC Monomando fregadero caño abatible

Sink mixer folding | Mitigeur évier rabattable | Spültischmischer kippbares  
смеситель для мойки складной носик

Ref.

Color

VI2050

VI2050CO

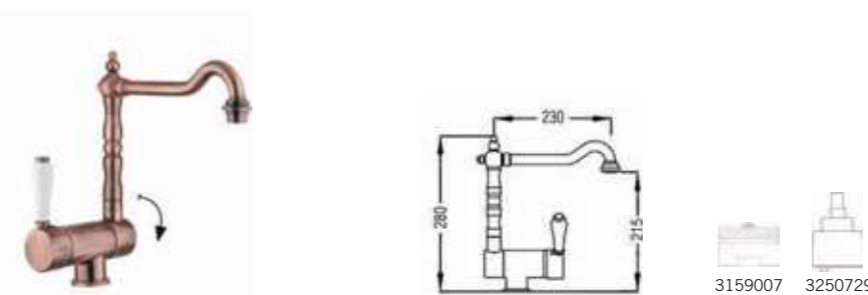

## 1921 RETRO MAJESTIC Monomando fregadero

Sink mixer | Mitigeur évier | смеситель для мойки

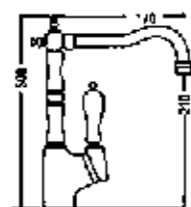

3159007



3250729

Ref.	Color
097501	●
097501BR	●
097501RU	●

## 1921 RETRO BARROCO Bimando fregadero

Sink mixer | Mélangeur évier | Spültischbatterie | смеситель для мойки

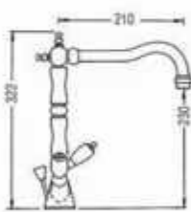

3240706



3159007



3240707

Ref.	Color
485008	●
485008BR	●
485008RU	●

## 1921 RETRO SIXTINA Bimando fregadero

Sink mixer | Mélangeur évier | Spültischbatterie | смеситель для мойки

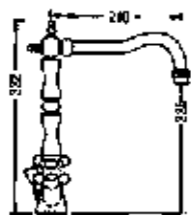

3159007



3240707

Ref.	Color
475008	●
475008BR	●
475008RU	●

## 1921 RETRO Bimando fregadero

Sink mixer | Mélangeur évier | Spültischbatterie | смеситель для мойки

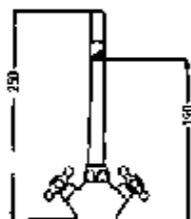

3159008



3240707

Ref.	Color
225008	●
225008BR	●
225008RU	●



## 1921 RETRO Fregadero 1 agua

Sink mixer | Mitigeur évier | Spültischmischer | смеситель для мойки встроенный

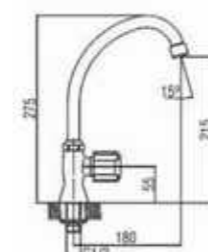

3159008



3240714

Ref.	Color
205000	●
205000BR	●
205000RU	●

## GRANADA Monomando fregadero caño abatible

Sink mixer folding | Mitigeur évier rabattable | Spültischmischer kippbares  
смеситель для мойки складной носик

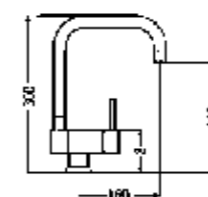

3250729



3159010

Ref.	Color
VI0336	●

# COCINAS | Sobre repisa

## CORFU Monomando fregadero

Sink mixer | Mitigeur évier | смеситель для мойки

Ref. SC3506 Color ●

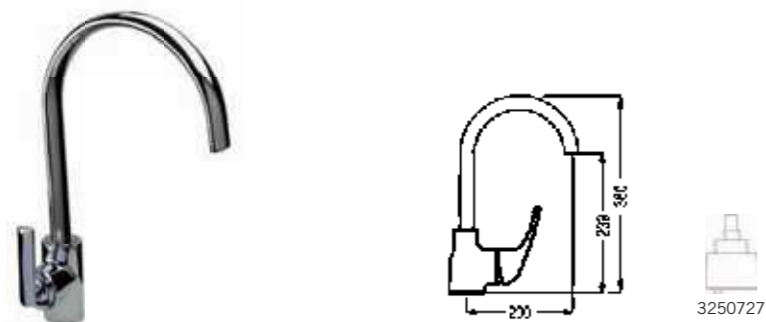

## CLINICO Monomando fregadero maneta gerontológica

Sink mixer, gerontological handle | Mitigeur évier, manette gérontologique  
Einhebel Spültischmischer gerontologie | Смеситель для мойки

Ref. 329601 Color ●

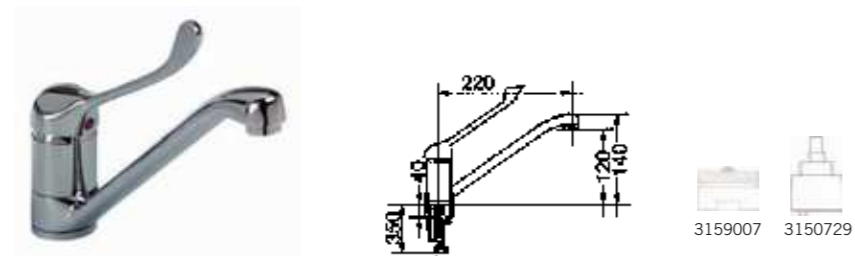

## CC1 Monomando fregadero

Sink mixer | Mitigeur évier | смеситель для мойки

Ref. 422501 Color ●

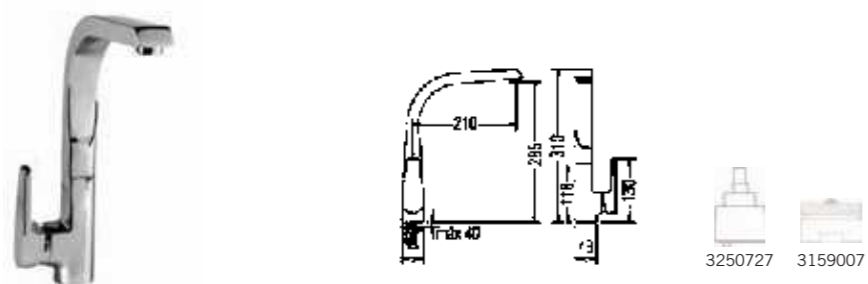

## WILLY Maneta Cristal - Monomando fregadero

Sink mixer | Mitigeur évier | смеситель для мойки

Ref. 687501CB  
687501CL  
687501CN  
687501CR  
687501CP  
687501NA Color ○ ● ● ● ● ●

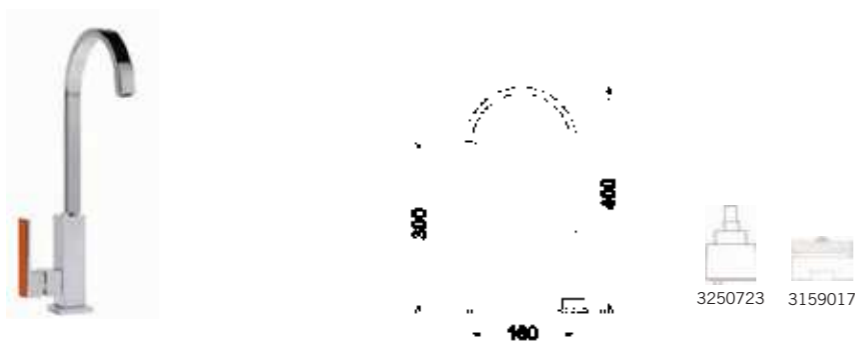

## AMS & AMS Play Monomando fregadero

Sink mixer | Mitigeur évier | смеситель для мойки

Ref. 767501  
767501P\* Color ● ●

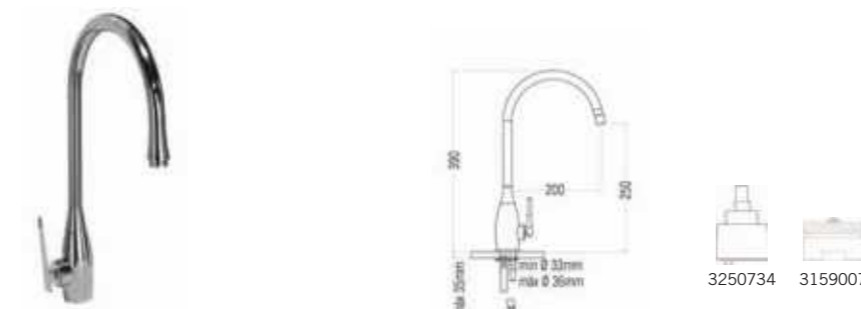

## ARTE Monomando fregadero

Sink mixer | Mitigeur évier | смеситель для мойки

**NEW** Ref. 687502 Color ●

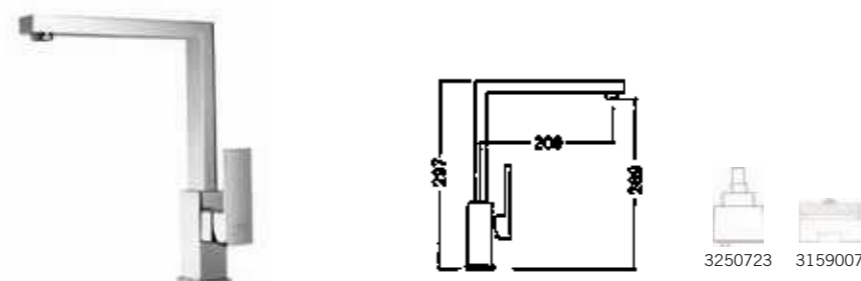

## JUMA Monomando fregadero

Sink mixer | Mitigeur évier | смеситель для мойки

Ref. SC3501 Color ●

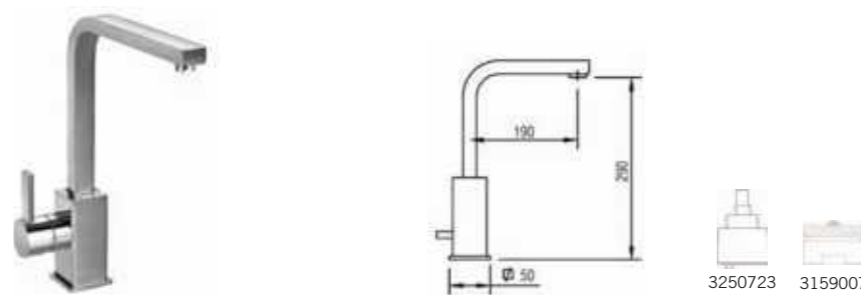

## ARTE Monomando fregadero

Sink mixer | Mitigeur évier | смеситель для мойки

Ref. 687501  
**NEW** 687501BL Color ● ○

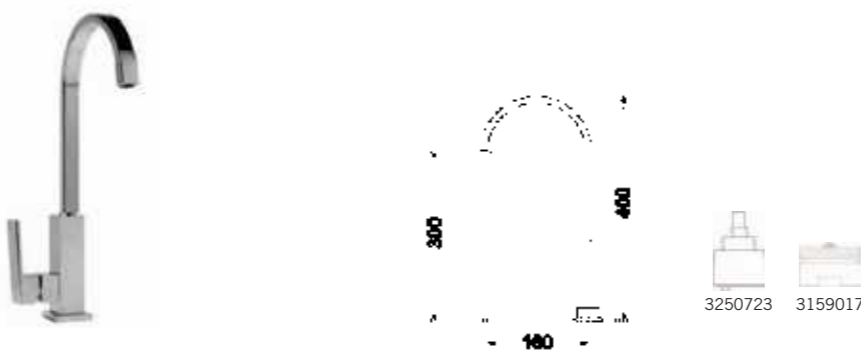

## GRANADA Monomando fregadero

Sink mixer | Mitigeur évier | смеситель для мойки

Ref.

Color

668502

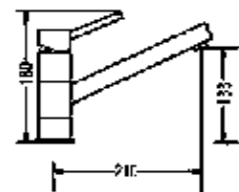

3250727 3159014

## GRANADA Monomanfo fregadero

Sink mixer | Mitigeur évier | смеситель для мойки

Ref.

Color

668501



**NEW** 668501BL



**NEW** 668501BP



**NEW** 668501NP

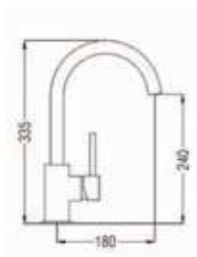

3250727 3159010

## ELBA Monomando fregadero

Sink mixer | Mitigeur évier | смеситель для мойки

Ref.

Color

556501



**NEW** 556501BL

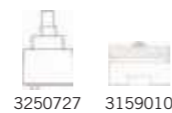
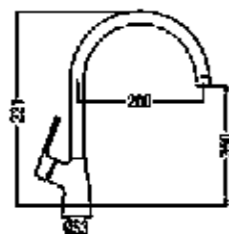

3250727 3159010

## RIALTO Monomando fregadero

Sink mixer | Mitigeur évier | смеситель для мойки

Ref.

Color

827562

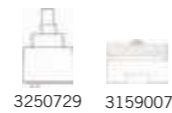
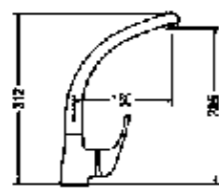

3250729 3159007

## GOAH Monomando fregadero

Sink mixer | Mitigeur évier | смеситель для мойки

Ref.

Color

SC4506

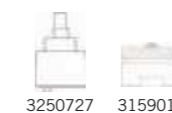
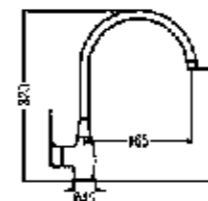

3250727 3159012

## AUCKLAND Monomando fregadero

Sink mixer | Mitigeur évier | смеситель для мойки

Ref.

Color

365514

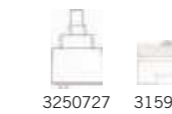
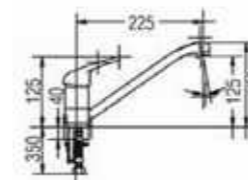

3250727 3159007

## PARIS Fregadero 1 agua

Sink mixer | Mitigeur évier | Spültischmischer | смеситель для мойки

Ref.

Color

605000

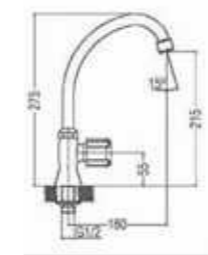

3159008 3240706

## MIKONOS Monomando fregadero

Sink mixer | Mitigeur évier | смеситель для мойки

Ref.

Color

175501

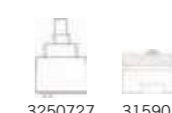
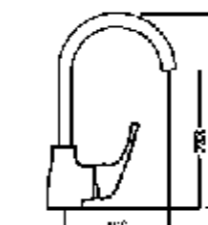

3250727 3159010

## AKTIVA Monomando fregadero

Sink mixer | Mélangeur évier | Spültischbatterie | смеситель для мойки

**NEW**

Ref.

847562

Color

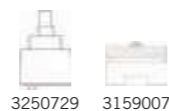
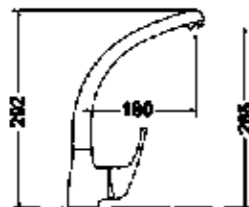

3250729 3159007

## ÉPOCA Monomando fregadero

Sink mixer | Mélangeur évier | Spültischbatterie | смеситель для мойки

**NEW**

Ref.

615008

Color



615008BR

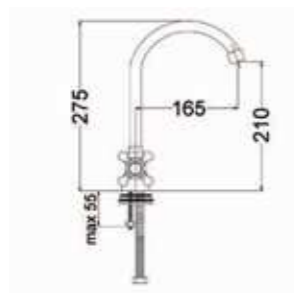

3240706 3159008

## ALFA 2 Monomando fregadero para sistemas de osmosis

Single lever sink osmotic systems | Mitigeur évier systèmes osmotiques  
Einhebel Spültischmischer osmotische Systeme | Смеситель для мойки

Ref.

OMS79501

Color

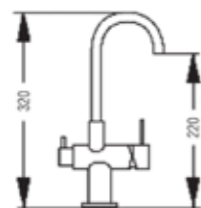

## ALFA 1 Monomando fregadero para sistemas de osmosis

Single lever sink osmotic systems | Mitigeur évier systèmes osmotiques  
Einhebel Spültischmischer osmotische Systeme | Смеситель для мойки

Ref.

S97104

Color

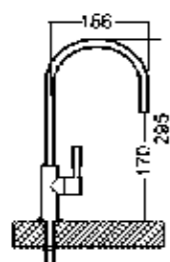

## CHEF 750 Monomando fregadero vertical; Ducha de dos posiciones

Sink mixer; shower with two positions | Mitigeur évier; douchette 2 positions  
Einhebel Spültischmischer; Geschirrbrause 2-fach verstellbar  
Смеситель для мойки с вытягивающимся распылителем 2 позиции

Ref. **VI3198** Color ●

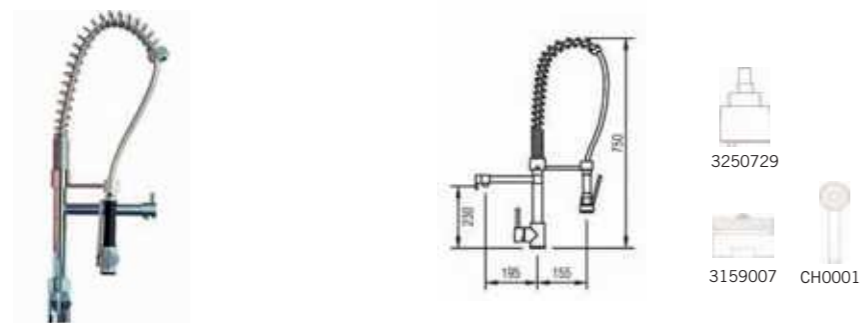

## ZINNIA Monomando fregadero con rociador extraíble 2 posociones

sink mixer with removable spout 2 operations | Mitigeur évier avec bec extractible 2 fonctions  
Spültischmischer mit pull-out 2-Positionen  
Смеситель для мойки с вытягивающимся распылителем 2 позиции

Ref. **S96755** Color ●

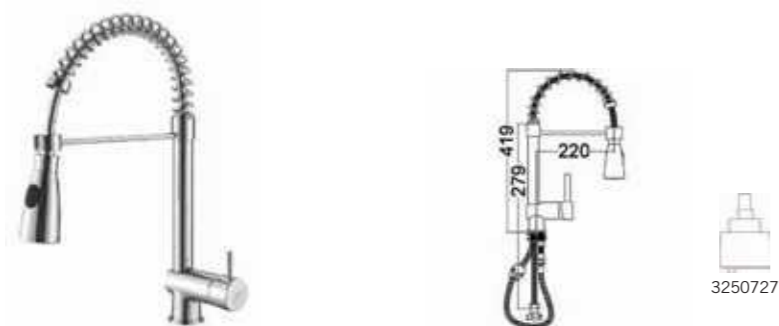

## MRT 1-E Monomando fregadero con rociador extraíble 2 posiciones

Sink mixer with removable spout 2 operations | Mitigeur évier avec bec extractible 2 fonctions  
Spültischmischer mit pull-out 2-Positionen  
Смеситель для мойки с вытягивающимся распылителем 2 позиции

Ref. **VI3103** Color ●

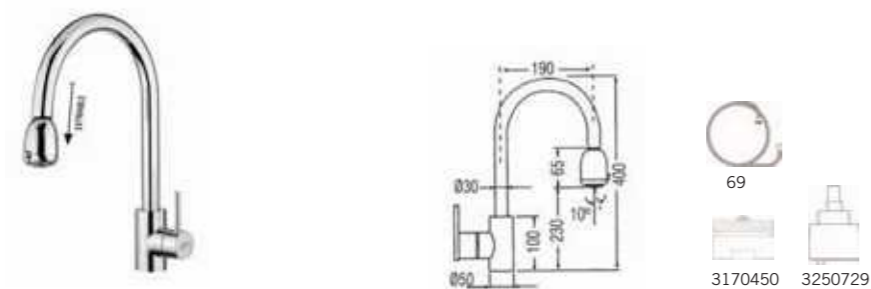

## LADY Monomando fregadero con rociador extraíble

Sink mixer with removable spout | Mitigeur évier avec bec extractible  
Spültischmischer mit pull-out | Смеситель для мойки с вытягивающимся распылителем

Ref. **VI4009** Color ●



## NONAME Monomando fregadero con rociador extraíble 2 posiciones

Sink mixer with removable spout 2 operations  
Mitigeur évier avec bec extractible 2 fonctions  
Spültischmischer mit pull-out 2-Positionen  
Смеситель для мойки с вытягивающимся распылителем 2 позиции

Ref. **N07501** Color ●  
**NEW** **N07501BL** Color ○

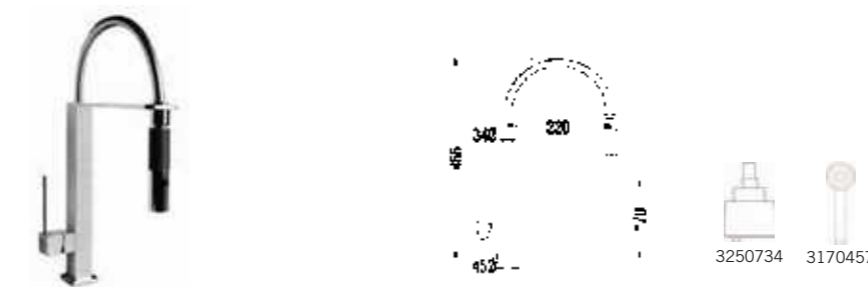

## PQ Monomando fregadero con rociador extraíble 2 posiciones

Sink mixer with removable spout 2 operations  
Mitigeur évier avec bec extractible 2 fonctions  
Spültischmischer mit pull-out 2-Positionen  
Смеситель для мойки с вытягивающимся распылителем 2 позиции

Ref. **PQ7501** Color ●  
**NEW** **PQ7501BL** Color ○



## ANGEL TWO-E Monomando fregadero con rociador extraíble 2 posiciones

Sink mixer with removable spout 2 operations | Mitigeur évier avec bec extractible 2 fonctions  
Spültischmischer mit pull-out 2-Positionen  
Смеситель для мойки с вытягивающимся распылителем 2 позиции

Ref. **VI4003** Color ●



## SPIRIT-E Monomando fregadero con rociador extraíble

Sink mixer with removable spout | Mitigeur évier avec bec extractible  
Spültischmischer mit pull-out | Смеситель для мойки с вытягивающимся распылителем

Ref. **VI4004** Color ●

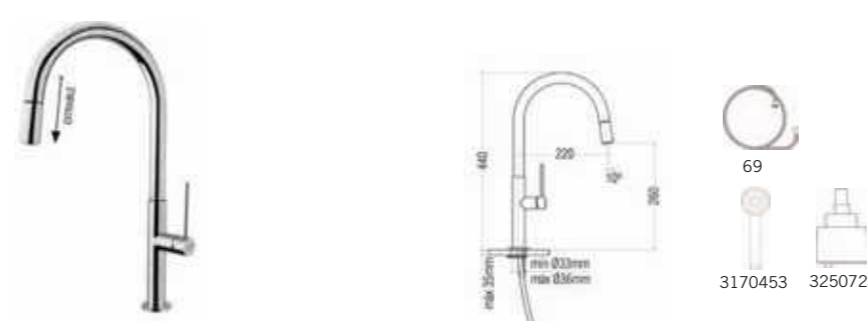

Caño giratorio  
Dirigible  
Ducha dos posiciones

Caño giratorio  
Dirigible  
Ducha dos posiciones

## GRANADA Monomando fregadero con rociador extraíble

Sink mixer with removable spout | Mitigeur évier avec bec extractible  
Spültischmischer mit pull-out  
Смеситель для мойки с вытягивающимся распылителем

**NEW**

Ref. 666516 Color ●

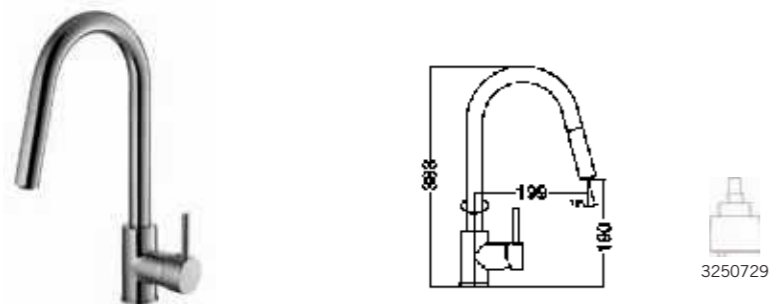

## ELAN Monomando fregadero con rociador extraíble

Sink mixer with removable spout | Mitigeur évier avec bec extractible  
Spültischmischer mit pull-out | Смеситель для мойки с вытягивающимся распылителем

Ref. SC9901 Color ●

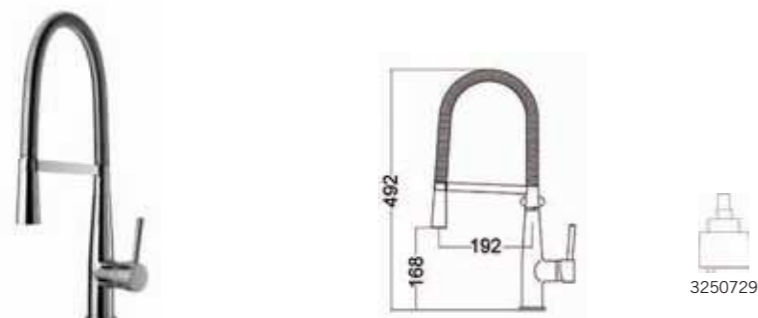

## HEAD Monomando fregadero con rociador extraíble 2 posiciones

Sink mixer with removable spout 2 operations  
Mitigeur évier avec bec extractible 2 fonctions | Spültischmischer mit pull-out 2-Positionen  
Смеситель для мойки с вытягивающимся распылителем 2 позиции встроенный

**NEW**

Ref. SC9916 Color ●

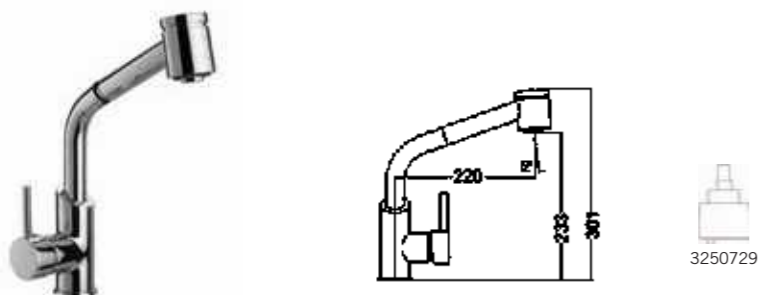

## CC1-E Monomando fregadero con rociador extraíble 2 posiciones

Sink mixer with removable spout 2 operations | Mitigeur évier avec bec extractible 2 fonctions  
Spültischmischer mit pull-out 2-Positionen  
Смеситель для мойки с вытягивающимся распылителем 2 позиции встроенный

Ref. 422516 Color ●

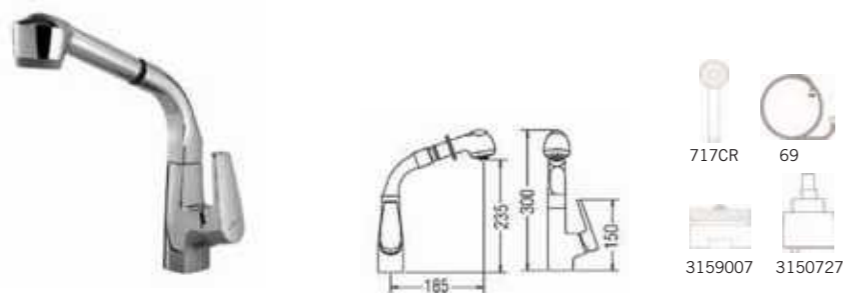

## ZK Monomando fregadero mural un agua

Sink mixer | Mitigeur évier | Spültischmischer | Смеситель для мойки

**NEW**

Ref.

VI4030

Color



## BARROCO Bimando fregadero

Wall mounted sink mixer | Mélangeur a mur | Einhebel Spültischmischer  
Смеситель для мойки

**NEW**

Ref.

485100

Color



485100BR



485100RU

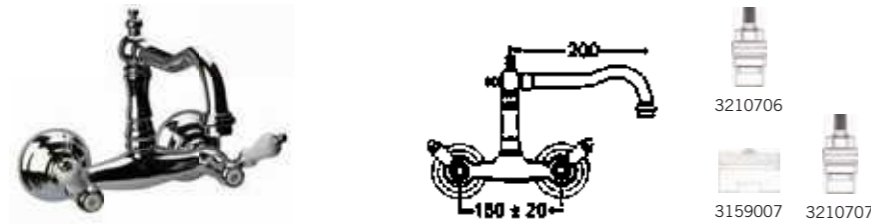

## 1921 RETRO Bimando fregadero

Wall mounted sink mixer | Mélangeur a mur | Einhebel Spültischmischer  
Смеситель для мойки

Ref.

225100

Color



225100BR



225100RU

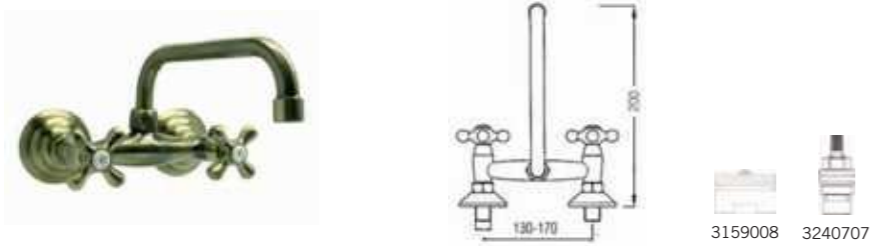

## 1921 RETRO Fregadero 1 agua

Sink mixer | Mitigeur évier | Spültischmischer | Смеситель для мойки

Ref.

205005

Color



205005BR



205005RU

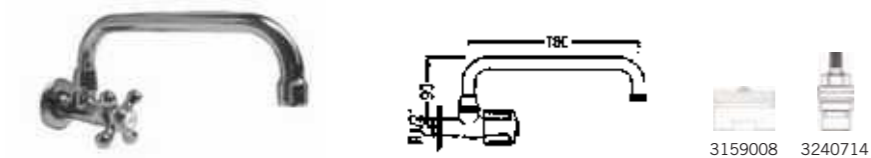

## ARTE Monomando fregadero mural

Single lever wall sink mixer | Mitigeur évier mural | Einhebel Spültischmischer  
Смеситель для мойки

**NEW**

Ref.

687509

Color



## ARTE Monomando fregadero mural con inversor

Single lever wall sink mixer | Mitigeur évier mural | Einhebel Spültischmischer  
Смеситель для мойки

**NEW**

Ref.

687529

Color



## CLINICO Monomando fregadero maneta gerontológica

Sink mixer, gerontological handle | Mitigeur évier, manette gérontologique  
Einhebel Spültischmischer gerontologie | Смеситель для мойки

Ref.

329602

Color

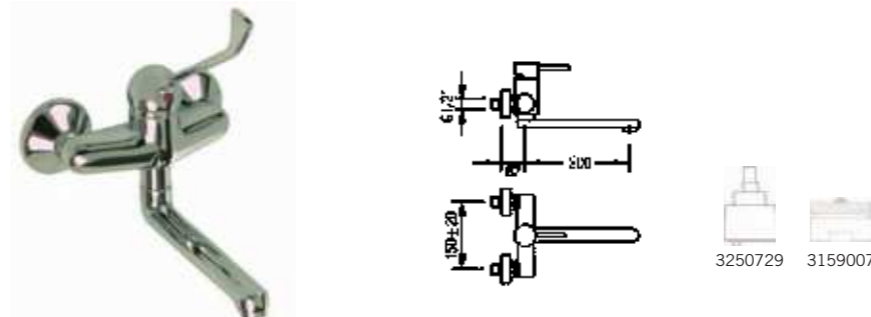

## CC1 Monomando fregadero mural

Single lever wall sink mixer | Mitigeur évier mural | Einhebel Spültischmischer  
Смеситель для мойки

Ref.

422509

Color

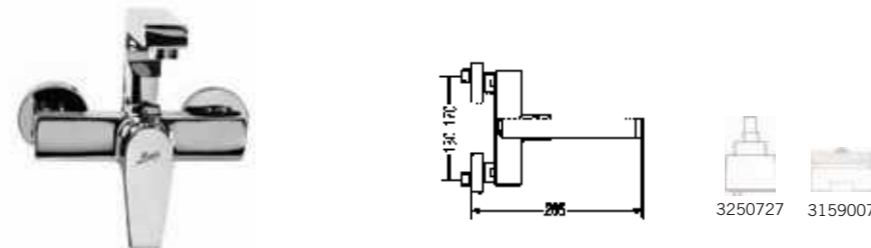



## RIALTO Monomando fregadero mural

Single lever wall sink mixer | Mitigeur évier mural | Einhebel Spültischmischer  
Смеситель для мойки

Ref. 820509 Color ●

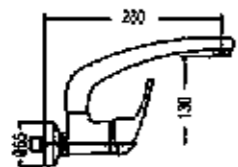

3250729 3179007

## RIALTO Monomando fregadero mural 9-13

Single lever wall sink mixer | Mitigeur évier mural | Einhebel Spültischmischer  
Смеситель для мойки

Ref. 820519 Color ●

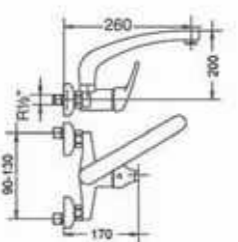

3250729 3179007

## AUCKLAND Monomando fregadero mural

Single lever wall sink mixer | Mitigeur évier mural | Einhebel Spültischmischer  
Смеситель для мойки

Ref. 366509 Color ●

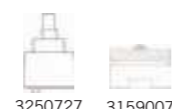
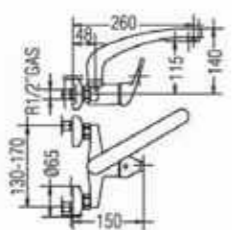

3250727 3159007

## GRANADA Monomando fregadero mural

Single lever wall sink mixer | Mitigeur évier mural | Einhebel Spültischmischer  
Смеситель для мойки

Ref. 668509 Color ●

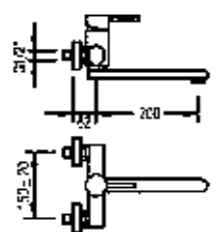

3250727 3159007

## PARIS Bimando fregadero mural

Wall mounted sink mixer | Mélangeur a mur | Einhebel Spültischmischer  
Смеситель для мойки

Ref. 605012 (9-13 cm) ●  
605114 (13-17 cm) ●

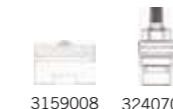
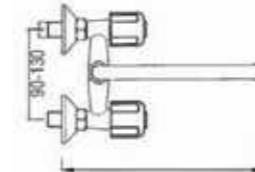

3159008 3240706

## PARIS Fregadero 1 agua

Sink mixer | Mitigeur évier | Spültischmischer | смеситель для мойки

Ref. 605005 Color ●

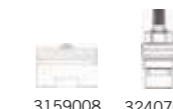
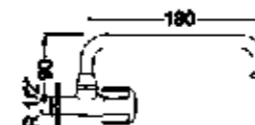

3159008 3240706



# ALGORA

Suave



## ALGORA Monomando lavabo

Wash-basin mixer | Mitigeur lavabo | Einhebel waschtischmischer  
смеситель для раковины Однорычажный Смеситель для раковины

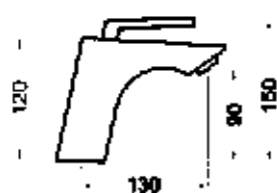

Ref.	Color
113101	●
113101CRBL	○
113101CRNE	●
113102 <i>cv</i>	●
113102CRBL <i>cv</i>	○
113102CRNE <i>cv</i>	●

*cv: válvula clic clac*

## ALGORA Monomando lavabo empotrado

Built-in single-lever wash-basin mixer | Mitigeur lavabo mural à encastrer  
Unterputz Einhebel wannenmischer | Однорычажный Смеситель для раковины встроенный

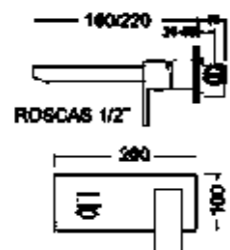

Ref.	Color
118108	●

## ALGORA Monomando bidé

Bidet mixer | Mitigeur bidet | Einhebel bidetmischer | Однорычажный Смеситель для Биде

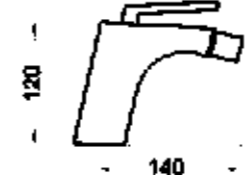

Ref.	Color
113201	●
113201CRBL	○
113201CRNE	●
113202 <i>cv</i>	●
113202CRBL <i>cv</i>	○
113202CRNE <i>cv</i>	●

*cv: válvula clic clac*

## ALGORA Monomando empotrar para bidé/wc

Built-in bidet mixer wc | Mitigeur bidet/wc à encastrer  
Set messing unterputz-mischer mit handbrause  
Однорычажный смеситель для биде, встраиваемый

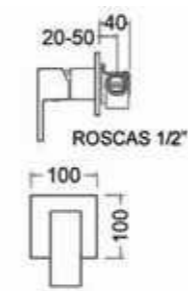

Ref.	Color
112515	●

## ALGORA Monomando ducha

Shower mixer with accessories | Mitigeur douche avec accessoires  
Einhebel duschmischer mit Zubehör | Однорычажный Смеситель для душа с аксессуарами

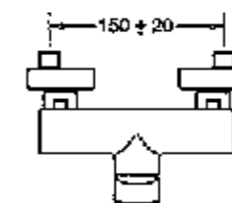

Ref.	Color
113401	●
113401CRBL	○
113401CRNE	●

## ALGORA Monomando empotrado ducha

Built-in shower mixer | Mitigeur douche à encastrer | Unterputz duschmischer  
Однорычажный Смеситель встроенный для душа

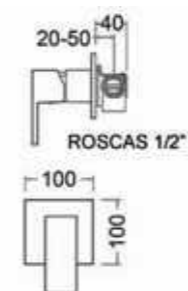

Ref.	Color
112415	●



## ALGORA Monomando baño ducha

Bath/shower mixer with accessories | Mitigeur bain-douche avec accessoires  
 Einhebel wannen und duschmischer mit Zubehör  
 Однорычажный Смеситель для ванны и душа с аксессуарами

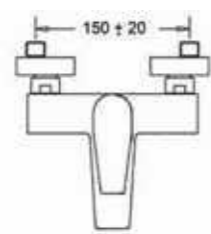

Ref.	Color
113301	●
113301CRBL	○
113301CRNE	●

## ALGORA Monomando empotrar baño ducha

Built-in bath/shower mixer | Mitigeur bain-douche à encastrer  
 Unterputz wannen und duschmischer | Одно рычажный Смеситель встроенный ванна душ

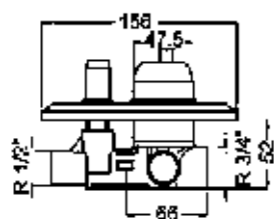

Ref.	Color
112414	●

## ALGORA Kit monomando ducha empotrado

Kit built-in shower | Kit Mitigeur douche a encastrer | Kit Unterputz duschmischer  
 Комплект встраиваемого однорычажного душа

Ref.	Color
KT1101	●

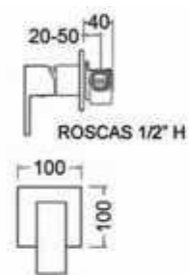

## ALGORA Kit monomando ducha empotrado dos funciones

Kit built-in shower with two functions  
 Kit Mitigeur douche a encastrer avec deux fonction | Kit Brausebatterie, zwei Funktionen  
 Комплект встраиваемого однорычажного душа (две функции)

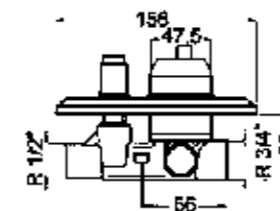

Ref.	Color
KT1102	●

## ALGORA Kit monomando ducha empotrado dos funciones

Kit built-in shower with two functions  
 Kit Mitigeur douche a encastrer avec deux fonction | Kit Brausebatterie, zwei Funktionen  
 Комплект встраиваемого однорычажного душа (две функции)

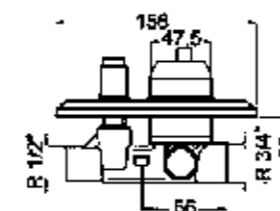

Ref.	Color
KT1103	●

# AMS

Original

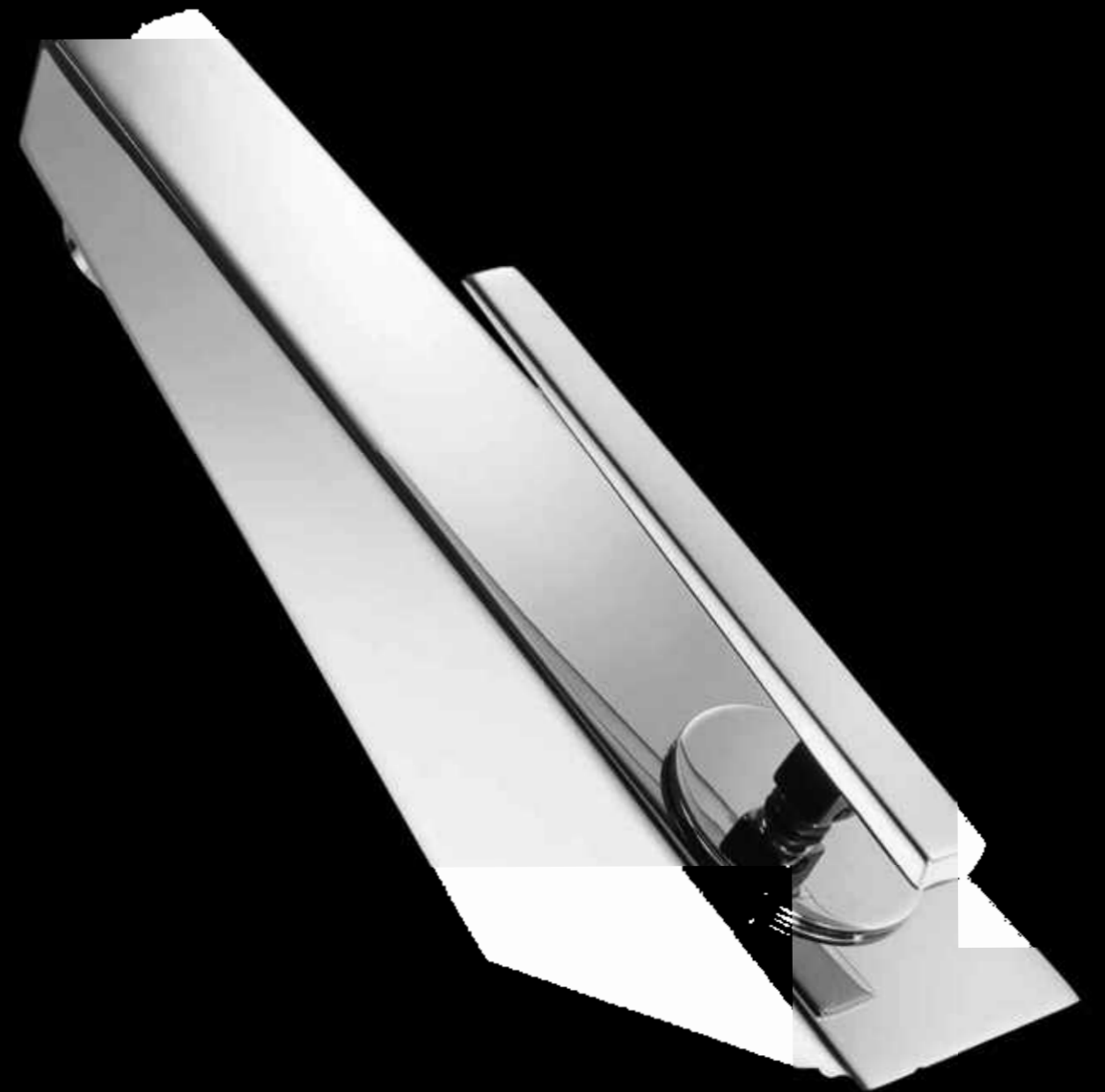

## AMS Monomando lavabo C/V

Wash-basin mixer | Mitigeur lavabo | Einhebel waschtischmischer  
Однорычажный Смеситель для раковины

Ref. Color

769101 ●

769102 *c/v* ●

*c/v: válvula clic clac*

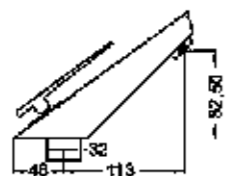

DX802R



3159007



3250734

## AMS Monomando lavabo empotrado

Built-in single-lever wash-basin mixer | Mitigeur lavabo mural à encastrer  
Unterputz Einhebel wannenmischer | Однорычажный Смеситель для раковины встроенный

Ref. Color

760306/22 ●

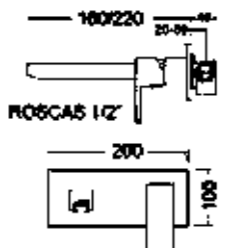

3159014



3250727

## AMS Monomando bidé

Bidet mixer | Mitigeur bidet | Einhebel bidetmischer | Однорычажный Смеситель для Биде

Ref. Color

769201 ●

769202 *c/v* ●

*c/v: válvula clic clac*

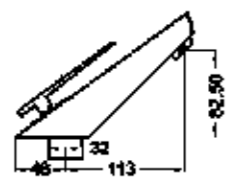

DX802R



3159027



3250734

## AMS Monomando empotrado para bidé/wc

Built-in bidet mixer wc | Mitigeur bidet/wc à encastrer  
Set messing unterputz-mischer mit handbrause  
Однорычажный смеситель для биде, встраиваемый

Ref. Color

762515 ●

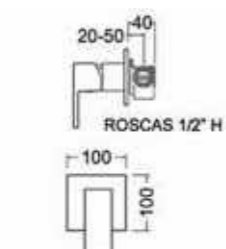

3250727

## AMS Monomando ducha con accesorios

Shower mixer with accessories | Mitigeur douche avec accessoires  
Einhebel duschmischer mit Zubehör | Однорычажный Смеситель для душа с аксессуарами

Ref. Color

769401 ●

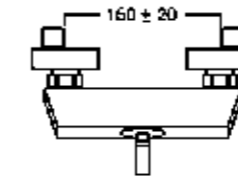

3250734



DX702L



DX10EC



DX302C

## AMS Monomando empotrado ducha

Built-in shower mixer | Mitigeur douche à encastrer | Unterputz duschmischer  
Однорычажный Смеситель встроенный для душа

Ref. Color

760102 ●

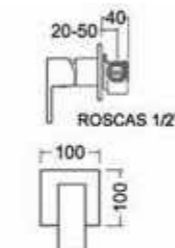

3250727

## AMS Monomando empotrar baño ducha

Built-in bath/shower mixer | Mitigeur bain-douche à encastrer | Unterputz wannen und duschmischer  
Однорычажный Смеситель встроенный ванна душ

Ref. Color

760105 ●

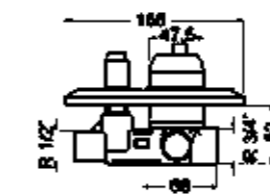

3250727



3150013

## AMS Monomando baño ducha con accesorios

Bath/shower mixer with accessories | Mitigeur bain-douche avec accessoires  
Einhebel wannen und duschmischer mit Zubehör  
Однорычажный Смеситель для ванны и душа с аксессуарами

Ref. Color

769301 ●

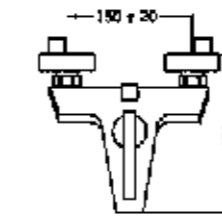

3159007



3150024



DX302C



DX103C



3250734



DX702L

## AMS Kit monomando ducha empotrado

Kit built-in shower | Kit Mitigeur douche a encastrer | Kit Unterputz duschmischer  
Комплект встраиваемого однорычажного душа

Ref. **KT7601** Color ●

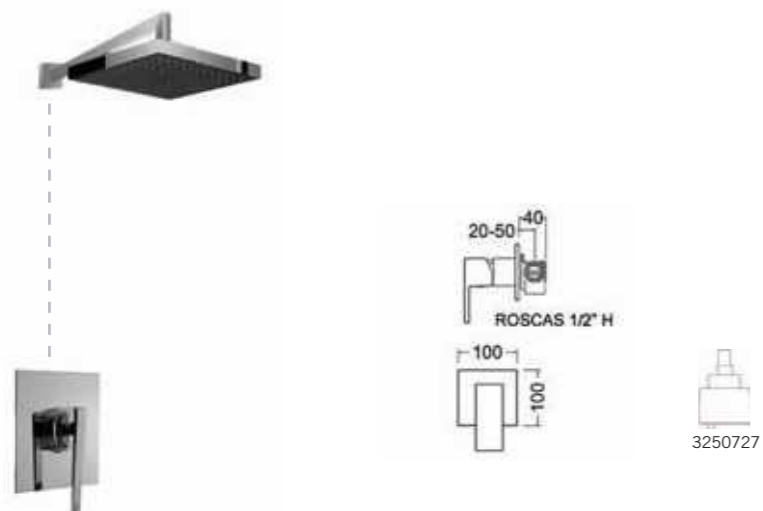

## AMS Kit monomando ducha empotrado dos funciones

Kit built-in shower with two functions  
Kit Mitigeur douche a encastrer avec deux fonction | Kit Brausebatterie, zwei Funktionen  
Комплект встраиваемого однорычажного душа (две функции)

Ref. **KT7603** Color ●



## AMS Kit monomando ducha empotrado dos funciones

Kit built-in shower with two functions  
Kit Mitigeur douche a encastrer avec deux fonction | Kit Brausebatterie, zwei Funktionen  
Комплект встраиваемого однорычажного душа (две функции)

Ref. **KT7602** Color ●



# AMS PLAY

Cromática  
Divertida  
Emocionante...

Si elije la versión PLAY  
en cualquiera de sus acabados base:  
CROMO, BLANCO, NEGRO,  
recibirá completando el conjunto  
5 palancas de mando  
para combinar a su gusto...  
cuando guste.

Colores:  
ROJO, FUCSIA, VIOLETA,  
BLANCO, NEGRO, CROMADA.

Practique el PLAYING!





## AMS Play Monomando lavabo C/V

Wash-basin mixer | Mitigeur lavabo | Einhebel waschtischmischer  
Однорычажный Смеситель для раковины

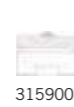
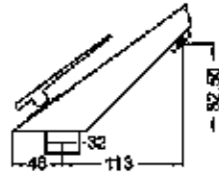

Ref. Color

769102P *CV* ●

769102PNE *CV* ●

769102PBL *CV* ○

*CV*: válvula clic clac



## AMS Play Monomando lavabo empotrado

Built-in single-lever wash-basin mixer | Mitigeur lavabo mural à encastrer  
Unterputz Einhebel wannenmischer | Однорычажный Смеситель для раковины встроенный

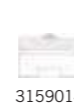
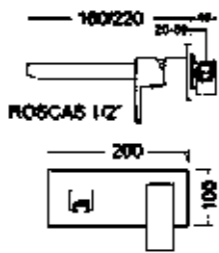

Ref. Color

760306P/22 ●



## AMS Play Monomando bidé

Bidet mixer | Mitigeur bidet | Einhebel bidetmischer | Однорычажный Смеситель для Биде

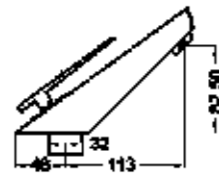

Ref. Color

769202P ●

769202PNE ●

769202PBL ○



## AMS Play Monomando empotrado para bide/wc

Built-in bidet mixer wc | Mitigeur bidet/wc à encastrer  
Set messing unterputz-mischer mit handbrause  
Однорычажный смеситель для биде, встраиваемый

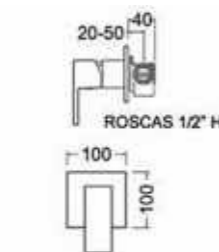

Ref. Color

762515P ●



## AMS Play Monomando ducha con accesorios

Shower mixer with accessories | Mitigeur douche avec accessoires  
Einhebel duschmischer mit Zubehör | Однорычажный Смеситель для душа с аксессуарами

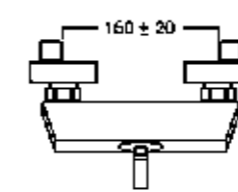

Ref. Color

769401P ●

769401PBL ●

769401PNE ○



## AMS Play Monomando empotrado ducha

Built-in shower mixer | Mitigeur douche à encastrer | Unterputz duschmischer  
Однорычажный Смеситель встроенный для душа

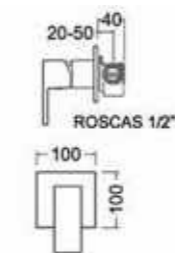

Ref. Color

769102P ●



## AMS Play Monomando empotrado baño ducha

Built-in bath/shower mixer | Mitigeur bain-douche à encastrer | Unterputz wannen und duschmischer  
Однорычажный Смеситель встроенный ванна душ

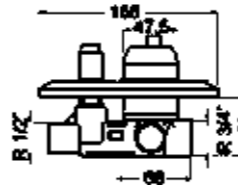

Ref. Color

760105P ●



## AMS Play Monomando baño ducha con accesorios

Bath/shower mixer with accessories | Mitigeur bain-douche avec accessoires  
Einhebel wannen und duschmischer mit Zubehör  
Однорычажный Смеситель для ванны и душа с аксессуарами

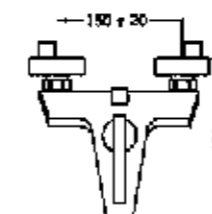

Ref. Color

769301P ●

769301PBL ●

769301PNE ○



## AMS Kit monomando ducha empotrado

Kit built-in shower | Kit Mitigeur douche a encastrer | Kit Unterputz duschmischer  
Комплект встраиваемого однорычажного душа

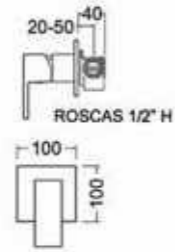
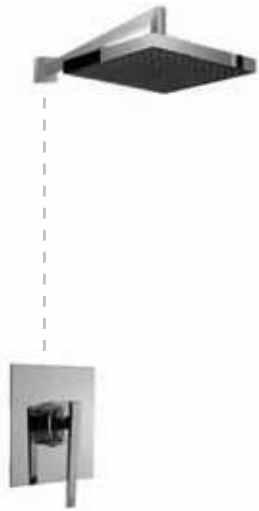

Ref. Color

KT7601P ●



## AMS Kit monomando ducha empotrado dos funciones

Kit built-in shower with two functions  
Kit Mitigeur douche a encastrer avec deux fonction | Kit Brausebatterie, zwei Funktionen  
Комплект встраиваемого однорычажного душа (две функции)

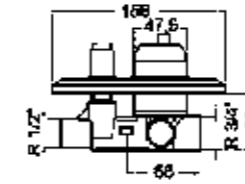

Ref. Color

KT7603P ●



## AMS Kit monomando ducha empotrado dos funciones

Kit built-in shower with two functions  
Kit Mitigeur douche a encastrer avec deux fonction | Kit Brausebatterie, zwei Funktionen  
Комплект встраиваемого однорычажного душа (две функции)

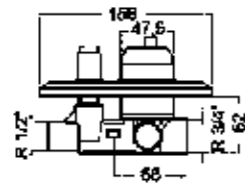

Ref. Color

KT7602P ●



# CARLO

Sensual



*Martí*  
1921  
barcelona

## CARLO Monomando lavabo

Wash-basin mixer | Mitigeur lavabo | Einhebel waschtischmischer  
Однорычажный Смеситель для раковины

Ref. Color

193101 ●

193102 *cv* ●

*cv*: válvula clic clac

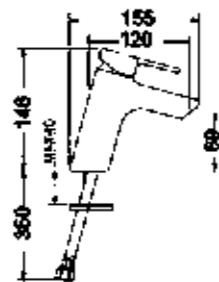

## CARLO Monomando lavabo efecto cascada

Basin mixer waterfall effect | Mitigeur lavabo cascade  
Einhebel waschtischmischer | Однорычажный смеситель с эффектом каскада

Ref. Color

193121 ●

193122 *cv* ●

*cv*: válvula clic clac

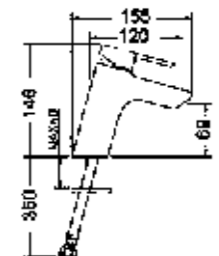

## CARLO Monomando lavabo empotrado

Built-in single-lever wash-basin mixer | Mitigeur lavabo mural à encastrer  
Unterputz Einhebel wappenmischer | Однорычажный Смеситель для раковины встроенный

Ref. Color

198108 ●

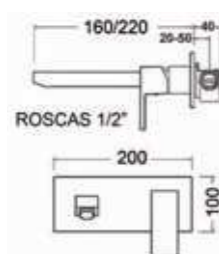

## CARLO Monomando bidé

Bidet mixer | Mitigeur bidet | Einhebel bidetmischer  
Однорычажный Смеситель для Биде

Ref. Color

193201 ●

193202 *cv* ●

*cv*: válvula clic clac

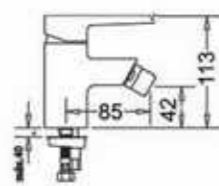

## CARLO Monomando empotrar para bidé/wc

Built-in bidet mixer wc | Mitigeur bidet/wc à encastrer  
Set messing unterputz-mischer mit handbrause  
Однорычажный смеситель для биде, встраиваемый

Ref. Color

192515 ●

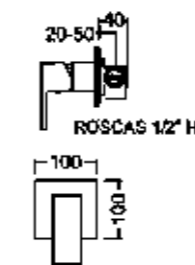

## CARLO Monomando ducha con accesorios

Shower mixer with accessories | Mitigeur douche avec accessoires  
Einhebel duschmischer mit Zubehör | Однорычажный Смеситель для душа с аксессуарами

Ref. Color

193481 ●

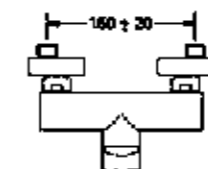

## CARLO Monomando empotrado ducha

Built-in shower mixer | Mitigeur douche à encastrer | Unterputz duschmischer  
Однорычажный Смеситель встроенный для душа

Ref. Color

192415 ●

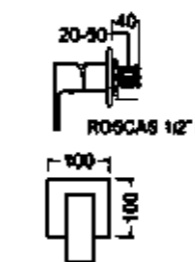

## CARLO Monomando empotrado baño ducha

Built-in bath/shower mixer | Mitigeur bain-douche à encastrer  
Unterputz wappen und duschmischer | Однорычажный Смеситель встроенный ванна душ

Ref. Color

192414 ●

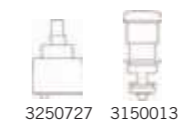
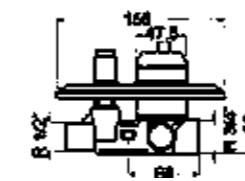

## CARLO Termostático ducha con accesorios

Thermostatic shower with equipment | Douche thermostatic avec un équipement  
Thermostatische Dusche mit Zubehör | Термостатический душ с аксессуарами

Ref. Color

TE1900 ●

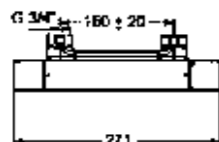

3250734P

## CARLO Empotrado termostático ducha

Built-in thermostatic shower | Mitigeur thermostatic douche a encastrer  
Thermostatische Duschel | Термостатический душ, встраиваемый

Ref. Color

TE889 ●

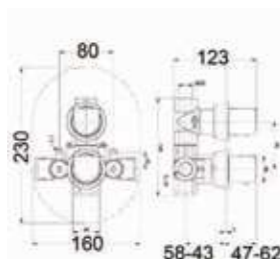

3250734P

## CARLO Monomando baño ducha con accesorios

Bath/shower mixer with accessories | Mitigeur bain-douche avec accessoires  
Einhebel wannen und duschmischer mit Zubehör  
Однорычажный Смеситель для ванны и душа с аксессуарами

Ref. Color

193381 ●

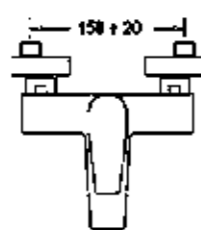

3159007

3150006

DX702L

DX105R

3250727

DX303R

## CARLO Empotrado termostático baño ducha

Built-in thermostatic bath-shower | Mitigeur thermostatic bain-douche a encastrer  
Einbathermostatische Thermostat Bad und Dusche  
Термостатический смеситель для душа и ванны

Ref. Color

TE888 ●

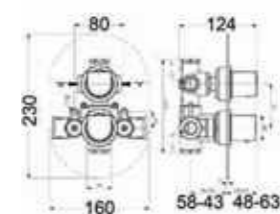

3250734P

## CARLO Termostático baño ducha con accesorios

Thermostatic bath-shower with equipment  
Bain-Douche thermostatic avec un équipement | Thermostatische Bad-Dusche mit Zubehör  
Термостатический смеситель для душа и ванны с аксессуарами

Ref. Color

TE1930 ●

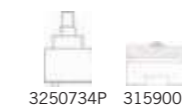
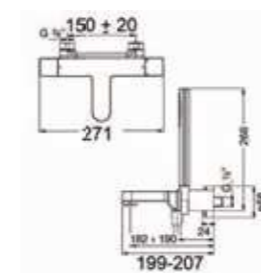

3250734P

3159007

## CARLO Kit monomando ducha empotrado

Kit built-in shower | Kit Mitigeur douche a encastrer | Kit Unterputz duschmischer  
Комплект встраиваемого однорычажного душа

Ref. Color

KT1901 ●

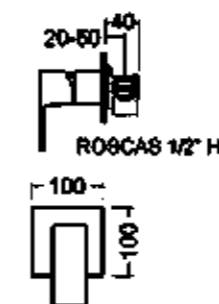

3250727

## CARLO Kit monomando ducha empotrado dos funciones

Kit built-in shower with two functions | Kit Mitigeur douche a encastrer avec deux fonction  
 Kit Brausebatterie, zwei Funktionen | Комплект встраиваемого однорычажного душа (две функции)

Ref.

Color

KT1902

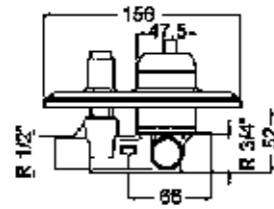

DX702L



3250727



3150013

## CARLO Kit monomando ducha empotrado dos funciones

Kit built-in shower with two functions | Kit Mitigeur douche a encastrer avec deux fonction  
 Kit Brausebatterie, zwei Funktionen | Комплект встраиваемого однорычажного душа (две функции)

Ref.

Color

KT1903

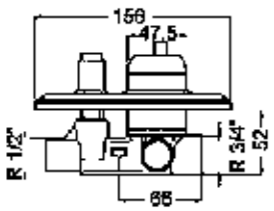

DX702L



3250727



3150013

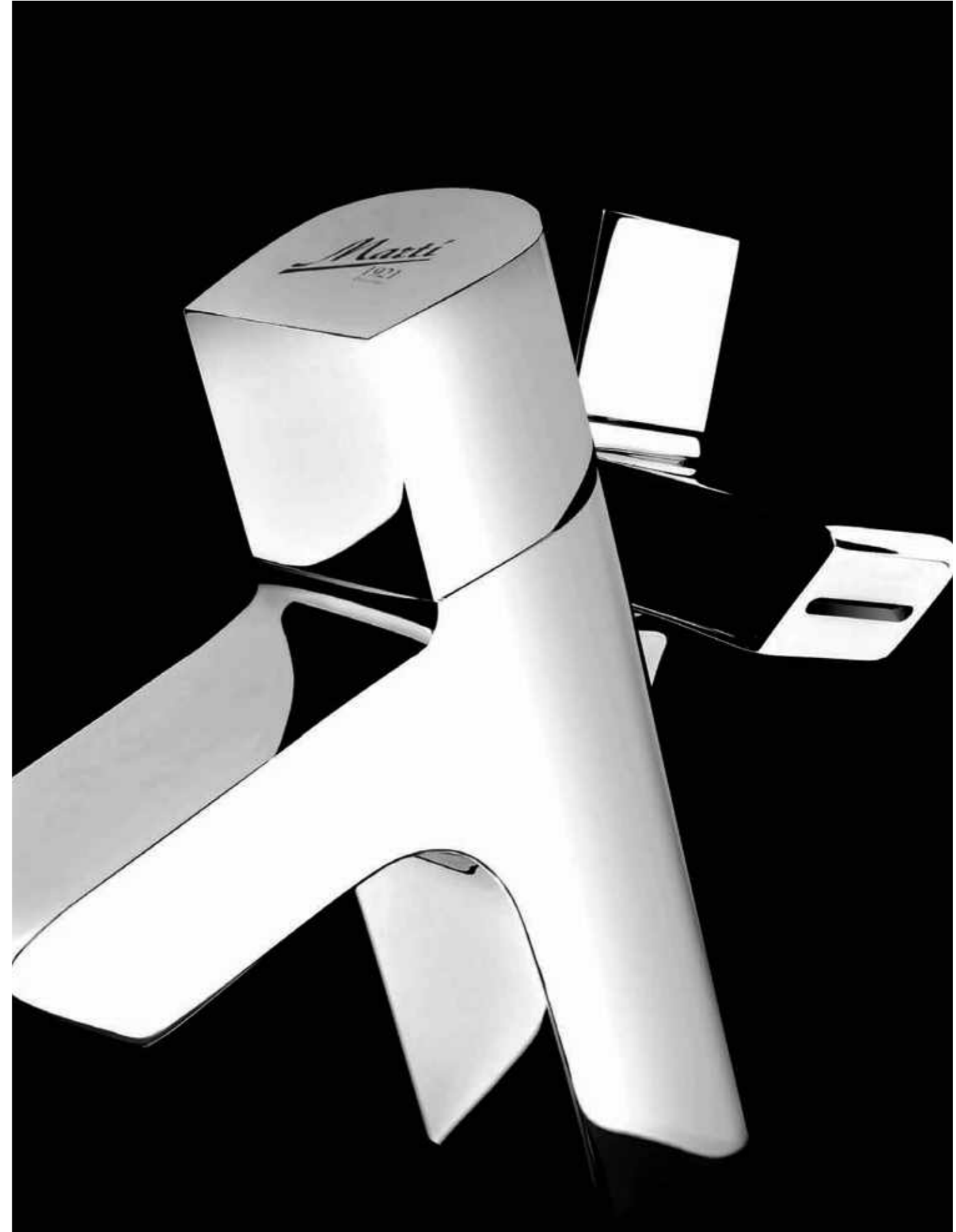

# CUBIC

El minimalismo

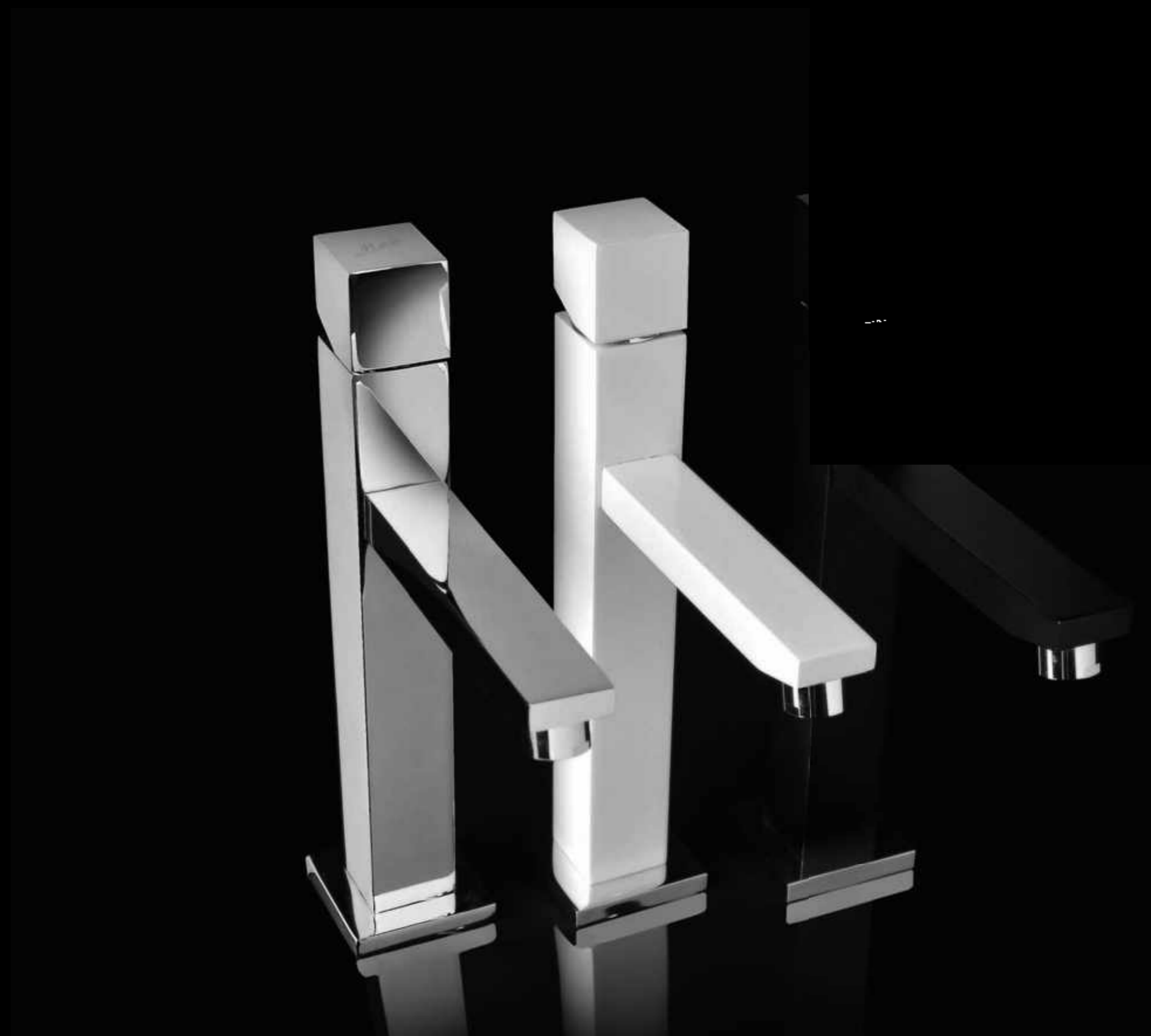

## CUBIC Monomando lavabo alto

High wash-basin mixer | Mitigeur lavabo haut  
Einhebel waschtischmischer Hohem ausführung  
Однорычажный Смеситель для раковин высокий

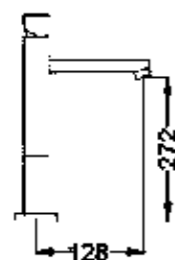

Ref.	Color
CM0321	●
CM0321NE	●
CM0321BL	○

## CUBIC Monomando bidé

Bidet mixer | Mitigeur bidet | Einhebel bidetmischer  
Однорычажный Смеситель для Биде



Ref.	Color
CM0361 <i>c/v</i>	●
CM0361NE <i>c/v</i>	●
CM0361BL <i>c/v</i>	○

*c/v: válvula clic clac*

## CUBIC Monomando lavabo empotrado

Built-in single-lever wash-basin mixer | Mitigeur lavabo mural à encastrer  
Unterputz Einhebel wannenmischer | Однорычажный Смеситель для раковины встроенный

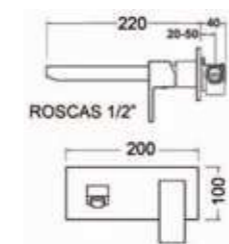

Ref.	Color
CM0306/22 <i>c/v</i>	●
CM0306/22NE <i>c/v</i>	●
CM0306/22BL <i>c/v</i>	○

*c/v: válvula clic clac*

## CUBIC Monomando lavabo medio

Wash-basin mixer | Mitigeur lavabo | Einhebel waschtischmischer  
Однорычажный Смеситель для раковины

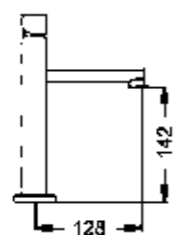

Ref.	Color
CM0328	●
CM0328NE	●
CM0328BL	○

## CUBIC Monomando empotrar para bidé/wc

Built-in bidet mixer wc | Mitigeur bidet/wc à encastrer  
Set messing unterputz-mischer mit handbrause  
Однорычажный смеситель для биде, встраиваемый

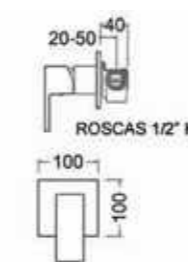

Ref.	Color
CM2515 <i>c/v</i>	●
CM2515NE <i>c/v</i>	●
CM2515BL <i>c/v</i>	○

*c/v: válvula clic clac*

## CUBIC Monomando lavabo

Wash-basin mixer | Mitigeur lavabo | Einhebel waschtischmischer  
Однорычажный Смеситель для раковины

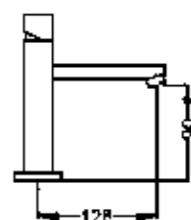

Ref.	Color
CM0320	●
CM0320NE	●
CM0320BL	○

## CUBIC Monomando ducha con accesorios

Shower mixer with accessories | Mitigeur douche avec accessoires  
Einhebel duschmischer mit Zubehör | Однорычажный Смеситель для душа с аксессуарами

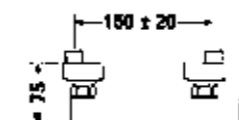

Ref.	Color
CM0104	●
CM0104NE	●
CM0104BL	○



## CUBIC Monomando empotrado ducha

Built-in shower mixer | Mitigeur douche à encastrer  
Unterputz duschmischer | Однорычажный Смеситель встроенный для душа

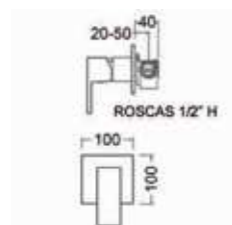

325727

Ref.	Color
CM0102	●
CM0102NE	●
CM0102BL	○

## CUBIC Monomando baño ducha con accesorios

Bath/shower mixer with accessories  
Mitigeur bain-douche avec accessoires | Einhebel wannen und duschmischer mit Zubehör  
Однорычажный Смеситель для ванны и душа с аксессуарами

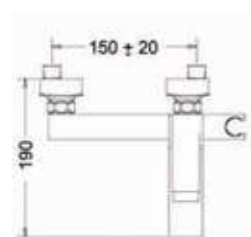

Ref.	Color
CM0204	●
CM0204NE	●
CM0204BL	○

## CUBIC Monomando empotrado baño ducha

Built-in bath/shower mixer | Mitigeur bain-douche à encastrer  
Unterputz wannen und duschmischer | Однорычажный Смеситель встроенный ванна душ

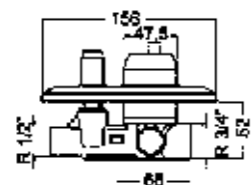

Ref.	Color
CM0105	●
CM0105NE	●
CM0105BL	○

## CUBIC Termostático ducha con accesorios

Thermostatic shower with equipment | Douche thermostatic avec un équipement.  
Thermostatische Dusche mit Zubehör | Термостатический душ с аксессуарами

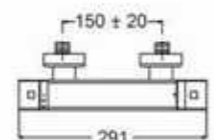

Ref.	Color
CT0104	●

## CUBIC Empotrado termostático ducha

Built-in thermostatic shower | Mitigeur thermostatic douche a encastrer  
Thermostatische Dusche | Термостатический душ, встраиваемый

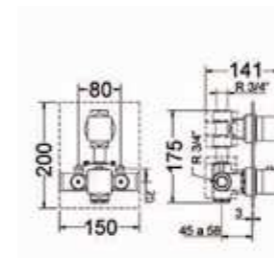

3250736

Ref.	Color
TE82901	●

## CUBIC Termostático baño ducha con accesorios

Thermostatic bath-shower with equipment | Bain-Douche thermostatic avec un équipement  
Thermostatische Bad-Dusche mit Zubehör  
Термостатический смеситель для душа и ванны с аксессуарами.

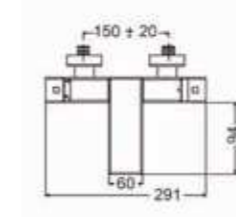

3250727

Ref.	Color
CT0204	●

## CUBIC Empotrado termostático baño ducha

Built-in thermostatic bath-shower | Mitigeur thermostatic bain-douche a encastrer  
Einbathermostatische Thermostat Bad und Dusche  
Термостатический смеситель для душа и ванны

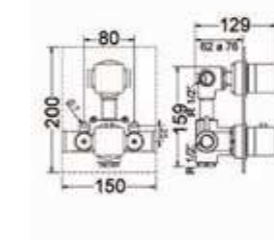

3250736

Ref.	Color
TE82801	●

## CUBIC Batería Termostática baño

Thermostatic bath-shower mixer | Bain-Douche thermostatic  
Thermostatische Bad-Dusche mit Zubehör | Термостатический для ванны и душа

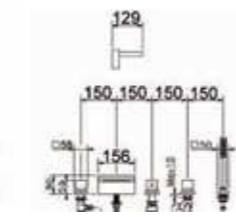

3250736

Ref.	Color
TE162EG	●

# REBEL

Radical



*Martí*  
1921  
barcelona

## REBEL Monomando lavabo

Wash-basin mixer | Mitigeur lavabo | Einhebel waschtischmischer  
Однорычажный Смеситель для раковины

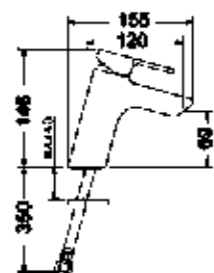

Ref. Color

163101 ●

163102 *cv* ●

*cv*: válvula clic clac

## REBEL Monomando empotrar para bidé/wc

Built-in bidet mixer wc | Mitigeur bidet/wc à encastrer  
Однорычажный смеситель для биде, встраиваемый

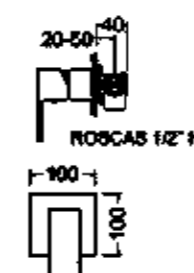

Ref. Color

162515 ●

## REBEL Monomando lavabo efecto cascada

Basin mixer waterfall effect | Mitigeur lavabo cascade | Einhebel waschtischmischer  
Однорычажный смеситель с эффектом каскада

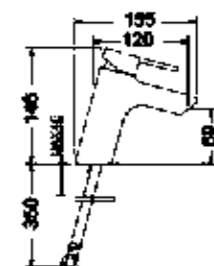

Ref. Color

163121 ●

163122 *cv* ●

*cv*: válvula clic clac

## REBEL Monomando ducha con accesorios

Shower mixer with accessories | Mitigeur douche avec accessoires  
Einhebel duschmischer mit Zubehör | Однорычажный Смеситель для душа с аксессуарами

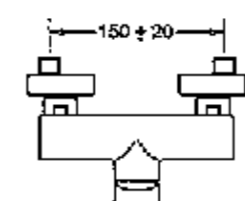

Ref. Color

163401 ●

## REBEL Monomando lavabo empotrado

Built-in single-lever wash-basin mixer | Mitigeur lavabo mural à encastrer  
Unterputz Einhebel wannenmischer | Однорычажный Смеситель для раковины встроенный

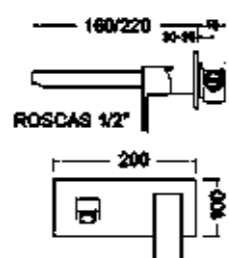

Ref. Color

168108 ●

## REBEL Monomando empotrado ducha

Built-in shower mixer | Mitigeur douche à encastrer | Unterputz duschmischer  
Однорычажный Смеситель встроенный для душа

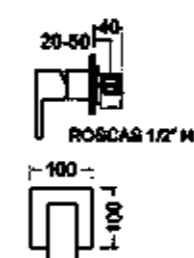

Ref. Color

162415 ●

## REBEL Monomando bidé

Bidet mixer | Mitigeur bidet | Einhebel bidetmischer  
Однорычажный Смеситель для Биде

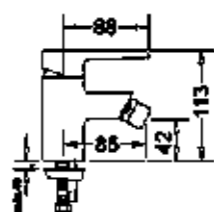

Ref. Color

163201 ●

163202 *cv* ●

*cv*: válvula clic clac

## REBEL Monomando empotrado baño ducha

Built-in bath/shower mixer | Mitigeur bain-douche à encastrer  
Unterputz wannen und duschmischer | Однорычажный Смеситель встроенный ванна душ

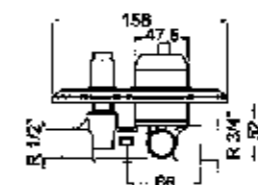

Ref. Color

162414 ●

## REBEL Monomando baño ducha con accesorios

Bath/shower mixer with accessories | Mitigeur bain-douche avec accessoires  
 Einhebel wannen und duschmischer mit Zubehör  
 Однорычажный Смеситель для ванны и душа с аксессуарами

Ref. Color

163301 ●

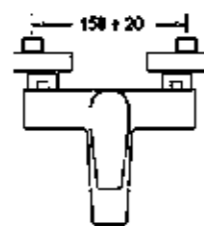

## REBEL Kit monomando ducha empotrado dos funciones

Kit built-in shower with two functions  
 Kit Mitigeur douche a encastrer avec deux fonction | Kit Brausebatterie, zwei Funktionen  
 Комплект встраиваемого однорычажного душа (две функции)

Ref. Color

KT1602 ●

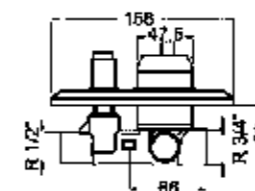

## REBEL Kit monomando ducha empotrado

Kit built-in shower | Kit Mitigeur douche a encastrer | Kit Unterputz duschmischer  
 Комплект встраиваемого однорычажного душа

Ref. Color

KT1601 ●

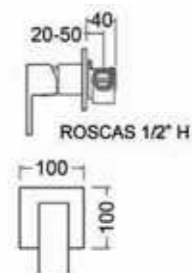

## REBEL Kit monomando ducha empotrado dos funciones

Kit built-in shower with two functions  
 Kit Mitigeur douche a encastrer avec deux fonction | Kit Brausebatterie, zwei Funktionen  
 Комплект встраиваемого однорычажного душа (две функции)

Ref. Color

KT1603 ●

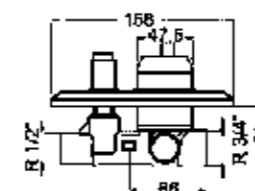

# RODANO

Es alcanzable



*Martí*  
1921  
barcelona

## RODANO Monomando lavabo

Wash-basin mixer | Mitigeur lavabo | Einhebel waschtischmischer  
Однорычажный Смеситель для раковины

Ref. Color

143181 ●

143182 *cv* ●

*cv*: válvula clic clac

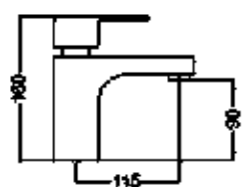

## RODANO Empotrado lavabo, caño de 22/16 cm

Built-in single-lever wash-basin mixer | Mitigeur lavabo mural à encastrer  
Unterputz Einhebel wannenmischer | Однорычажный Смеситель для раковины встроенный

Ref. Color

148108 ●

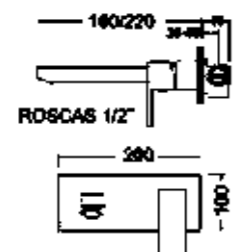

## RODANO Monomando bidé

Bidet mixer | Mitigeur bidet | Einhebel bidetmischer | Однорычажный Смеситель для Биде

Ref. Color

143281 *cv* ●

143282 *cv* ●

*cv*: válvula clic clac

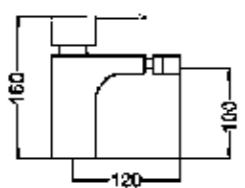

## RODANO Empotrado bidé/wc

Built-in bidet mixer wc | Mitigeur bidet/wc à encastrer  
Set messing unterputz-mischer mit handbrause  
Однорычажный смеситель для биде, встраиваемый

Ref. Color

142515 ●

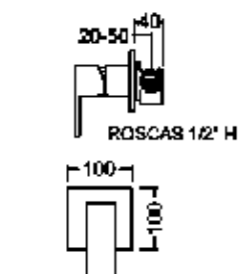

## RODANO Ducha con equipo

Shower mixer with accessories | Mitigeur douche avec accessoires  
Einhebel duschmischer mit Zubehör | Однорычажный Смеситель для душа с аксессуарами

Ref. Color

143481 ●

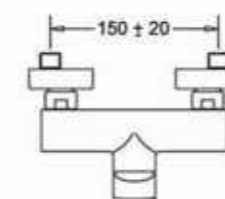

## RODANO Empotrado ducha

Built-in shower mixer | Mitigeur douche à encastrer | Unterputz duschmischer  
Однорычажный Смеситель встроенный для душа

Ref. Color

142415 ●

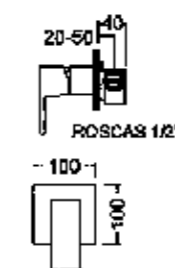

## RODANO Empotrado ducha con inversor

Built-in bath/shower mixer | Mitigeur bain-douche à encastrer | Unterputz wannenund duschmischer  
Однорычажный Смеситель встроенный ванна душ

Ref. Color

142414 ●



## RODANO Baño ducha con accesorios

Bath/shower mixer with accessories | Mitigeur bain-douche avec accessoires  
Einhebel wannen und duschmischer mit Zubehör  
Однорычажный Смеситель для ванны и душа с аксессуарами

Ref. Color

143381 ●

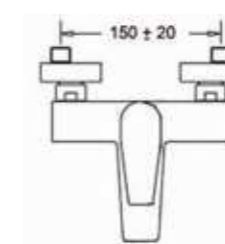

## RODANO Kit monomando ducha empotrado

Kit built-in shower | Kit Mitigeur douche a encastrer | Kit Unterputz duschmischer  
Комплект встраиваемого однорычажного душа

Ref. Color

KT1401 ●

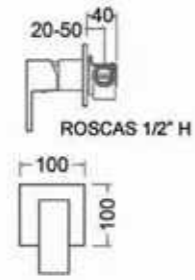

3250727

## RODANO Kit monomando ducha empotrado dos funciones

Kit built-in shower with two functions  
Kit Mitigeur douche a encastrer avec deux fonction | Kit Brausebatterie, zwei Funktionen  
Комплект встраиваемого однорычажного душа (две функции)

Ref. Color

KT1402 ●

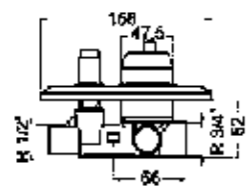

DX702L

3250727

3150013

## RODANO Kit monomando ducha empotrado dos funciones

Kit built-in shower with two functions  
Kit Mitigeur douche a encastrer avec deux fonction | Kit Brausebatterie, zwei Funktionen  
Комплект встраиваемого однорычажного душа (две функции)

Ref. Color

KT1403 ●

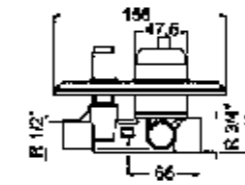

DX702L

3250727

3150013



# THE ONE

Fuerza

*Martí*  
1921  
barcelona





## THE ONE Monomando lavabo

Wash-basin mixer | Mitigeur lavabo | Einhebel waschtischmischer  
Однорычажный Смеситель для раковины

Ref. Color

133101 ●

133102 *cv* ●

*cv*: válvula clic clac

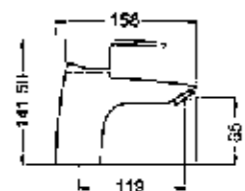

DX802R



3159007



3250725

## THE ONE Monomando lavabo empotrado

Built-in single-lever wash-basin mixer | Mitigeur lavabo mural à encastrer  
Unterputz Einhebel wannenmischer | Однорычажный Смеситель для раковины встроенный

Ref. Color

138108 ●

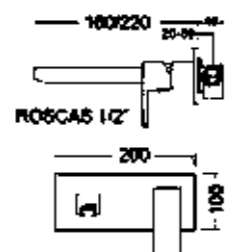

3159014



3250727

## THE ONE Monomando bidé

Bidet mixer | Mitigeur bidet | Einhebel bidetmischer | Однорычажный Смеситель для Биде

Ref. Color

133201 ●

133202 *cv* ●

*cv*: válvula clic clac

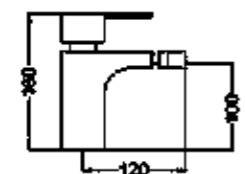

DX802R



3159027



3250727

## THE ONE Monomando empotrado para bidé/wc

Built-in bidet mixer wc | Mitigeur bidet/wc à encastrer  
Set messing unterputz-mischer mit handbrause  
Однорычажный смеситель для биде, встраиваемый

Ref. Color

132515 ●

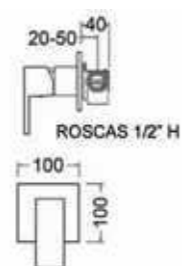

3250727

## THE ONE Monomando ducha con accesorios

Shower mixer with accessories | Mitigeur douche avec accessoires  
Einhebel duschmischer mit Zubehör | Однорычажный Смеситель для душа с аксессуарами

Ref. Color

133401 ●

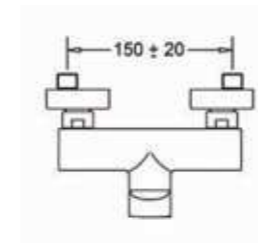

3250727



DX106R



DX702L



DX303R

## THE ONE Monomando empotrado ducha

Built-in shower mixer | Mitigeur douche à encastrer  
Unterputz duschmischer | Однорычажный Смеситель встроенный для душа

Ref. Color

132415 ●

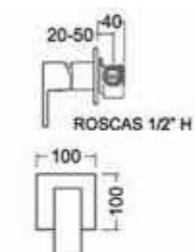

3250727

## THE ONE Monomando empotrado baño ducha

Built-in bath/shower mixer | Mitigeur bain-douche à encastrer  
Unterputz wannen und duschmischer | Однорычажный Смеситель встроенный ванна душ

Ref. Color

132414 ●

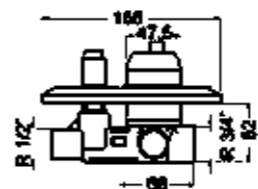

3250727



3150013

## THE ONE Monomando baño ducha con accesorios

Bath/shower mixer with accessories | Mitigeur bain-douche avec accessoires  
Einhebel wannen und duschmischer mit Zubehör  
Однорычажный Смеситель для ванны и душа с аксессуарами

Ref. Color

13301 ●

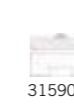
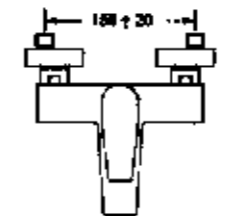

3159007



3150023



DX303R



DX106R



3250727



DX702L

## THE ONE Kit monomando ducha empotrado

Kit built-in shower | Kit Mitigeur douche a encastrer | Kit Unterputz duschmischer  
Комплект встраиваемого однорычажного душа

Ref.

Color

KT1301

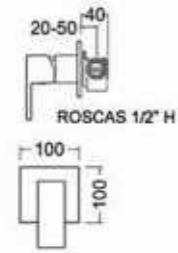

3250727

## THE ONE Kit monomando ducha empotrado dos funciones

Kit built-in shower with two functions  
Kit Mitigeur douche a encastrer avec deux fonction | Kit Brausebatterie, zwei Funktionen  
Комплект встраиваемого однорычажного душа (две функции)

Ref.

Color

KT1303

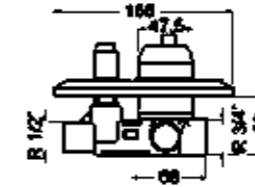

3150013

DX702L 3250727

## THE ONE Kit monomando ducha empotrado dos funciones

Kit built-in shower with two functions  
Kit Mitigeur douche a encastrer avec deux fonction | Kit Brausebatterie, zwei Funktionen  
Комплект встраиваемого однорычажного душа (две функции)

Ref.

Color

KT1302

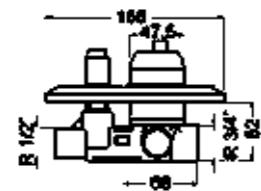

DX702L



3250727



3150013



# WILLY

Divertido

- CN - Negro
- CB - Blanco
- CL - Malva
- CR - Rojo
- NA - Naranja
- CP - Pistacho
- CH - Chocolate
- CA - Azul
- OR - Oro
- SA - Safari
- CF - Arco Iris

*Martí*  
1921  
barcelona



## WILLY Monomando lavabo

Wash-basin mixer | Mitigeur lavabo | Einhebel waschtischmischer  
Однорычажный Смеситель для раковины

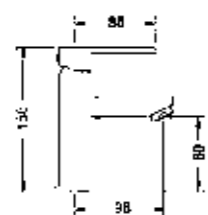

Ref. Color

- 687101CN *CV* ●
- 687101CB *CV* ○
- 687101CL *CV* ●
- 687101CR *CV* ●
- 687101NA *CV* ●
- 687101CP *CV* ●
- 687101CH *CV* ●
- 687101CA *CV* ●
- NEW** 687101OR *CV* ●
- NEW** 687101SA *CV* ●
- NEW** 687101CF *CV* ●

*c/v: válvula clic clac*

## WILLY Monomando lavabo empotrado

Built-in single-lever wash-basin mixer | Mitigeur lavabo mural à encastrer  
Unterputz Einhebel wannenmischer | Однорычажный Смеситель для раковины встроенный

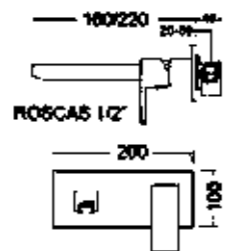

Ref. Color

- 688108CN ●
- 688108CB ○
- 688108CL ●
- 688108CR ●
- 688108NA ●
- 688108CP ●
- 688108CH ●
- 688108CA ●
- NEW** 688108OR ●
- NEW** 688108SA ●
- NEW** 687108CF ●

## WILLY Monomando bidé

Bidet mixer | Mitigeur bidet | Einhebel bidetmischer | Однорычажный Смеситель для Биде

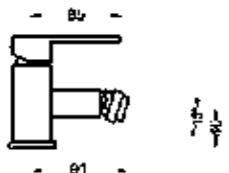

Ref. Color

- 687201CN *CV* ●
- 687201CB *CV* ○
- 687201CL *CV* ●
- 687201CR *CV* ●
- 687201NA *CV* ●
- 687201CP *CV* ●
- 687201CH *CV* ●
- 687201CA *CV* ●
- NEW** 687201OR *CV* ●
- NEW** 687201SA *CV* ●
- NEW** 687201CF *CV* ●

*c/v: válvula clic clac*

## WILLY Monomando empotrado para bidé/wc

Built-in bidet mixer wc | Mitigeur bidet/wc à encastrer  
Set messing unterputz-mischer mit handbrause  
Однорычажный смеситель для биде, встраиваемый

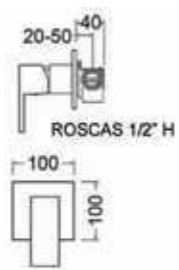

Ref. Color

- 682515CN ●
- 682515CB ○
- 682515CL ●
- 682515CR ●
- 682515NA ●
- 682515CP ●
- 682515CH ●
- 682515CA ●
- NEW** 682515OR ●
- NEW** 682515SA ●
- NEW** 687515CF ●

## WILLY Monomando ducha con accesorios

Shower mixer with accessories | Mitigeur douche avec accessoires  
Einhebel duschmischer mit Zubehör | Однорычажный Смеситель для душа с аксессуарами

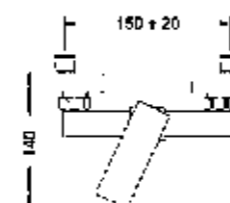

Ref. Color

- 687401CN ●
- 687401CB ○
- 687401CL ●
- 687401CR ●
- 687401NA ●
- 687401CP ●
- 687401CH ●
- 687401CA ●
- NEW** 687401OR ●
- NEW** 687401SA ●
- NEW** 687401CF ●

## WILLY Monomando empotrado ducha

Built-in shower mixer | Mitigeur douche à encastrer  
Unterputz duschmischer | Однорычажный Смеситель встроенный для душа

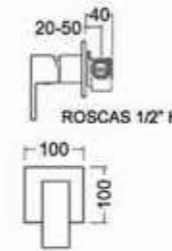

Ref. Color

- 680102CN ●
- 680102CB ○
- 680102CL ●
- 680102CR ●
- 680102NA ●
- 680102CP ●
- 680102CH ●
- 680102CA ●
- NEW** 680102OR ●
- NEW** 680102SA ●
- NEW** 687102CF ●

## WILLY Monomando empotrar baño ducha

Built-in bath/shower mixer | Mitigeur bain-douche à encastrer  
Unterputz wannen und duschmischer | Однорычажный Смеситель встроенный ванна душ

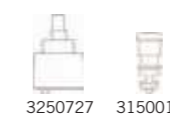
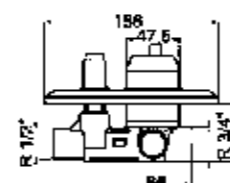

Ref. Color

- 680105CN ●
- 680105CB ○
- 680105CL ●
- 680105CR ●
- 680105NA ●
- 680105CP ●
- 680105CH ●
- 680105CA ●
- NEW** 680105OR ●
- NEW** 680105SA ●
- NEW** 687105CF ●

## WILLY Monomando baño ducha con accesorios

Bath/shower mixer with accessories | Mitigeur bain-douche avec accessoires  
Einhebel wannen und duschmischer mit Zubehör  
Однорычажный Смеситель для ванны и душа с аксессуарами

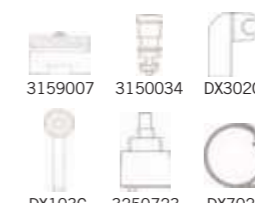
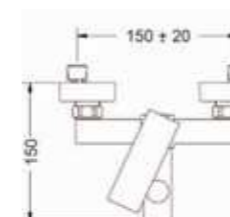

Ref. Color

- 687301CN ●
- 687301CB ○
- 687301CL ●
- 687301CR ●
- 687301NA ●
- 687301CP ●
- 687301CH ●
- 687301CA ●
- NEW** 687301OR ●
- NEW** 687301SA ●
- NEW** 687301CF ●

## WILLY Kit monomando ducha empotrado

Kit built-in shower | Kit Mitigeur douche a encastrer | Kit Unterputz duschmischer  
Комплект встраиваемого однорычажного душа

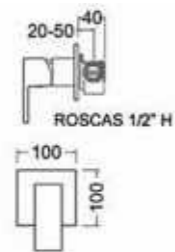

Ref.	Color
KT6801CN	●
KT6801CB	○
KT6801CL	●
KT6801CR	●
KT6801NA	●
KT6801CP	●
KT6801CH	●
KT6801CA	●
<b>NEW</b> KT6801OR	●
<b>NEW</b> KT6801SA	●
<b>NEW</b> KT6801CF	●

## WILLY Kit monomando ducha empotrado dos funciones

Kit built-in shower with two functions  
Kit Mitigeur douche a encastrer avec deux fonction | Kit Brausebatterie, zwei Funktionen  
Комплект встраиваемого однорычажного душа (две функции)

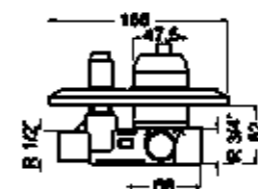

Ref.	Color
KT6803CN	●
KT6803CB	○
KT6803CL	●
KT6803CR	●
KT6803NA	●
KT6803CO	●
KT6803CH	●
KT6803CA	●
<b>NEW</b> KT6803OR	●
<b>NEW</b> KT6803SA	●
<b>NEW</b> KT6803CF	●

## WILLY Kit monomando ducha empotrado dos funciones

Kit built-in shower with two functions  
Kit Mitigeur douche a encastrer avec deux fonction | Kit Brausebatterie, zwei Funktionen  
Комплект встраиваемого однорычажного душа (две функции)

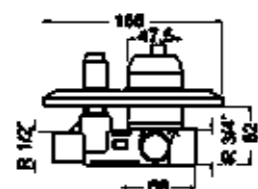

Ref.	Color
KT6802CN	●
KT6802CB	○
KT6802CL	●
KT6802CR	●
KT6802NA	●
KT6802CP	●
KT6802CH	●
KT6802CA	●
<b>NEW</b> KT6802OR	●
<b>NEW</b> KT6802SA	●
<b>NEW</b> KT6802CF	●



O<sup>2</sup>

Geometría



O<sup>2</sup> Monomando lavabo

Wash-basin mixer | Mitigeur lavabo | Einhebel waschtischmischer  
Однорычажный Смеситель для раковины

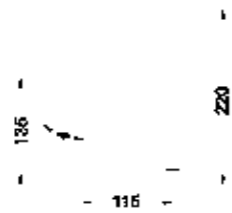

Ref.	Color
00300 <i>c/v</i>	●
00300NE <i>c/v</i>	●
00300BL <i>c/v</i>	○

*c/v*: válvula clic clac

O<sup>2</sup> Monomando ducha con accesorios

Shower mixer with accessories | Mitigeur douche avec accessoires  
Einhebel duschmischer mit Zubehör | Однорычажный Смеситель для душа с аксессуарами

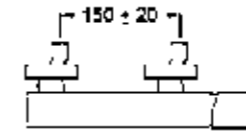

Ref.	Color
00104	●
00104NE	●
00104BL	○

O<sup>2</sup> Monomando empotrar ducha

Built-in shower mixer | Mitigeur douche à encastrer | Unterputz duschmischer  
Однорычажный Смеситель встроенный для душа

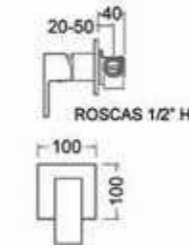

Ref.	Color
00102	●
00102NE	●
00102BL	○

O<sup>2</sup> Monomando lavabo empotrado

Built-in single-lever wash-basin mixer | Mitigeur lavabo mural à encastrer  
Unterputz Einhebel wannenmischer | Однорычажный Смеситель для раковины встроенный

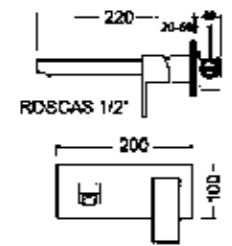

Ref.	Color
00306/22	●
00306/22NE	●
00306/22BL	○

O<sup>2</sup> Monomando empotrar baño ducha

Built-in bath/shower mixer | Mitigeur bain-douche à encastrer  
Unterputz wannen und duschmischer | Однорычажный Смеситель встроенный ванна душ

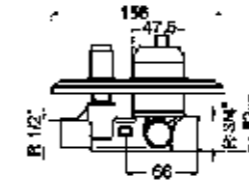

Ref.	Color
00105	●
00105NE	●
00105BL	○

O<sup>2</sup> Monomando bidé

Bidet mixer | Mitigeur bidet | Einhebel bidetmischer | Скрытая база душ смешиваются

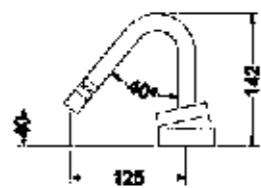

Ref.	Color
00351 <i>c/v</i>	●
00351NE <i>c/v</i>	●
00351BL <i>c/v</i>	○

*c/v*: válvula clic clac

O<sup>2</sup> Monomando baño ducha con accesorios

Bath/shower mixer with accessories | Mitigeur bain-douche avec accessoires  
Einhebel wannen und duschmischer mit Zubehör | Однорычажный Смеситель для ванны и душа с аксессуарами

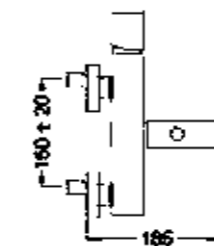

Ref.	Color
00204	●
00204NE	●
00204BL	○

# ICE

Luz propia



*Martí*  
1921  
barcelona



ICE Monomando lavabo

Wash-basin mixer | Mitigeur lavabo | Einhebel waschtischmischer  
Однорычажный Смеситель для раковины

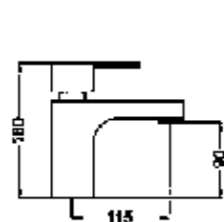

Ref.	Color
183181	●
183181OR	●
183182 CV	●
183182OR CV	●

c/v: válvula clic clac

ICE Monomando lavabo empotrado

Built-in single-lever wash-basin mixer | Mitigeur lavabo mural à encastrer  
Unterputz Einhebel wannenmischer | Однорычажный Смеситель для раковины встроенный

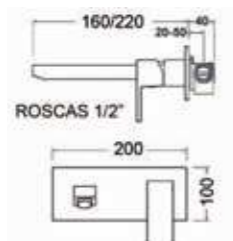

Ref.	Color
188108	●
188108OR	●

ICE Monomando bidé

Bidet mixer | Mitigeur bidet | Einhebel bidetmischer | Однорычажный Смеситель для Биде

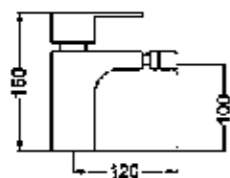

Ref.	Color
183281	●
183281OR	●
183282 CV	●
183282OR CV	●

c/v: válvula clic clac

ICE Monomando empotrado para bidé/wc

Built-in bidet mixer wc | Mitigeur bidet/wc à encastrer  
Set messing unterputz-mischer mit handbrause  
Однорычажный смеситель для биде, встраиваемый

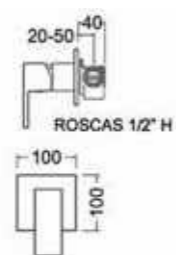

Ref.	Color
182515	●
182515OR	●

ICE Monomando ducha con accesorios

Shower mixer with accessories | Mitigeur douche avec accessoires  
Einhebel duschmischer mit Zubehör | Однорычажный Смеситель для душа с аксессуарами

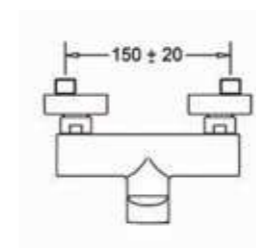

Ref.	Color
183481	●
183481OR	●

ICE Monomando empotrado ducha

Built-in shower mixer | Mitigeur douche à encastrer | Unterputz duschmischer  
Однорычажный Смеситель встроенный для душа

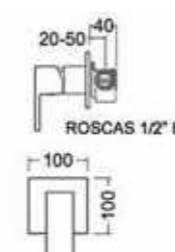

Ref.	Color
182415	●
182415OR	●

ICE Monomando empotrado baño ducha

Built-in bath/shower mixer | Mitigeur bain-douche à encastrer  
Unterputz wannen und duschmischer | Однорычажный Смеситель встроенный ванна душ

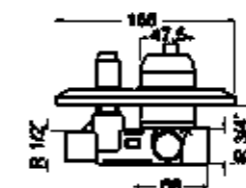

Ref.	Color
182414	●
182414OR	●

ICE Monomando baño ducha con accesorios

Bath/shower mixer with accessories | Mitigeur bain-douche avec accessoires  
Einhebel wannen und duschmischer mit Zubehör  
Однорычажный Смеситель для ванны и душа с аксессуарами

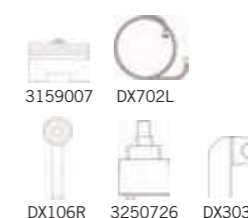
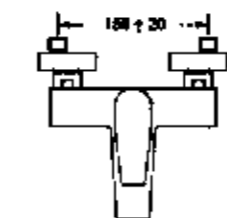

Ref.	Color
183381	●
183381OR	●

ICE Batería monomando baño

Bath-shower mixer | Mitigeur bain douche | S-loch Wannrand bad und duschmischer  
Смеситель для ванны на 4 отверстия

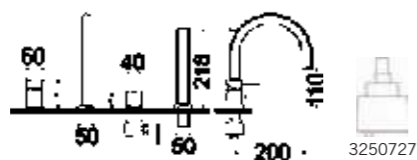

Ref.	Color
KT1804	●
KT1804OR	●

ICE Kit monomando ducha empotrado dos funciones

Kit built-in shower with two functions  
Kit Mitigeur douche a encastrer avec deux fonction | Kit Brausebatterie, zwei Funktionen  
Комплект встраиваемого однорычажного душа (две функции)

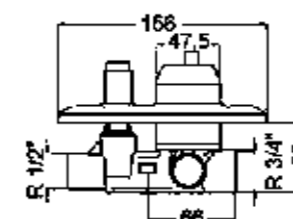

Ref.	Color
KT1802	●
KT1802OR	●

ICE Kit monomando ducha empotrado

Kit built-in shower | Kit Mitigeur douche a encastrer | Kit Unterputz duschmischer  
Комплект встраиваемого однорычажного душа

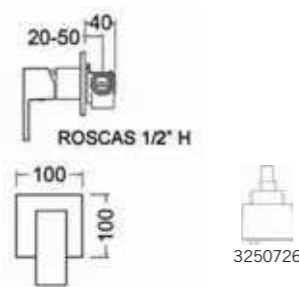

Ref.	Color
KT1801	●
KT1801OR	●

ICE Kit monomando ducha empotrado dos funciones

Kit built-in shower with two functions  
Kit Mitigeur douche a encastrer avec deux fonction | Kit Brausebatterie, zwei Funktionen  
Комплект встраиваемого однорычажного душа (две функции)

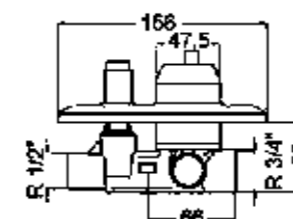

Ref.	Color
KT1803	●
KT1803OR	●

# ÉPOCA

Historia



## ÉPOCA Monobloc lavabo

Monobloc wash-basin | Mélangeur lavabo | Waschtischbatterie  
Смеситель для раковины

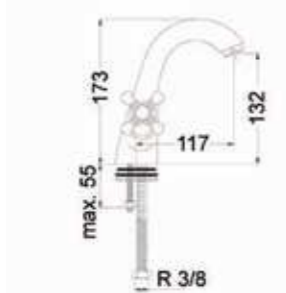

3159007 3240706

Ref.	Color
611004	●
611004BR	●
611049 <i>c/v</i>	●
611049BR <i>c/v</i>	●

*c/v: válvula clic clac*

## ÉPOCA Monobloc bidé

Single-hole bidet | Mélangeur bidet | Bidetbatterie  
Смеситель для Биде

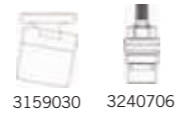
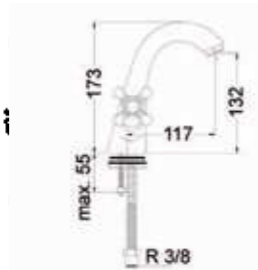

3159030 3240706

Ref.	Color
612508	●
612508BR	●
612514 <i>c/v</i>	●
612514BR <i>c/v</i>	●

*c/v: válvula clic clac*

## ÉPOCA Batería baño ducha con accesorios

Built-in bath/shower mixer with accessories | Mélangeur bain-douche avec accessoires  
Wannen und dusch batterie mit zuberhör | Набор ванна душ с аксессуарами

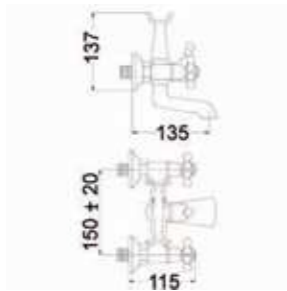

3240706

Ref.	Color
613519	●
6135198BR	●

## ÉPOCA Bimando empotrado ducha

Shower mixer with accessories | Mélangeur douche avec accessoires  
Dusch batterie mit zuberhör | смеситель для душа с аксессуарами

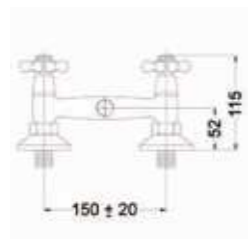

3240706

Ref.	Color
615110	●
615110BR	●

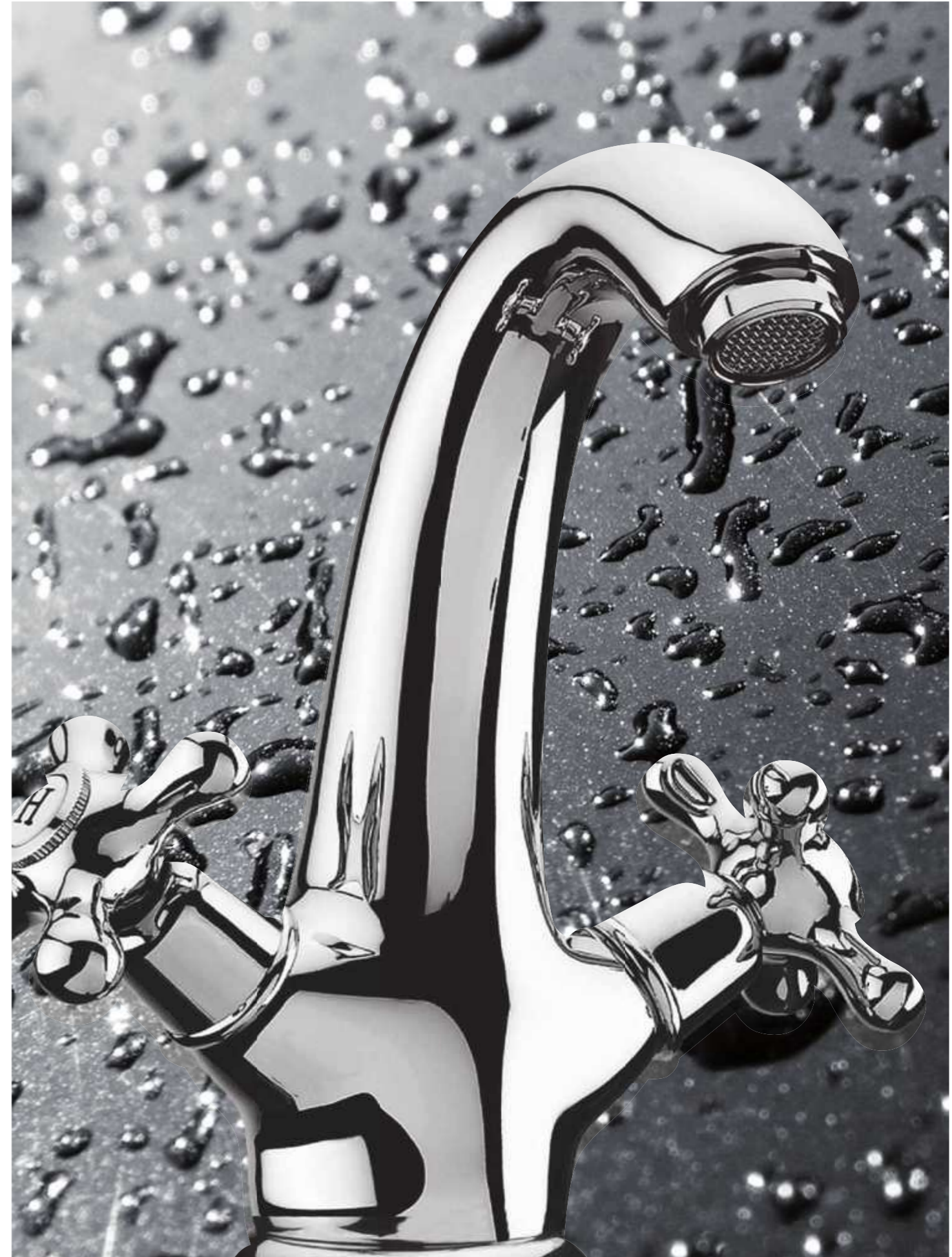

# SENA

Bonito



## SENA Monomando lavabo

Wash-basin mixer | Mitigeur lavabo | Einhebel waschtischmischer  
Однорычажный Смеситель для раковины

**NEW**  
A PARTIR DEL  
1 DE MAYO

Ref. Color

868101 ●

868102 CV ●

c/v: válvula clic clac

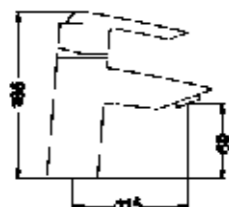

DX803E



3159007



3250729

## SENA Monomando bidé

Bidet mixer | Mitigeur bidet | Einhebel bidetmischer  
Однорычажный Смеситель для Биде

**NEW**  
A PARTIR DEL  
1 DE MAYO

Ref. Color

868201 ●

868202 CV ●

c/v: válvula clic clac

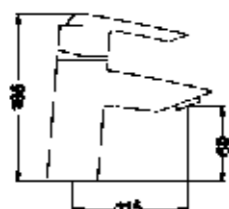

DX803E



3159027



3250729

## SENA Monomando ducha con accesorios

Shower mixer with accessories | Mitigeur douche avec accessoires  
Einhebel duschmischer mit Zubehör  
Однорычажный Смеситель для душа с аксессуарами

**NEW**  
A PARTIR DEL  
1 DE MAYO

Ref. Color

868401 ●

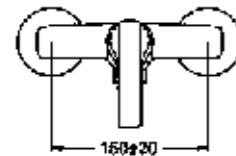

3250729



DX109R



DX304E



DX702L

## SENA Monomando empotrado ducha

Built-in shower mixer | Mitigeur douche à encastrer  
Unterputz duschmischer  
Однорычажный Смеситель встроенный для душа

**NEW**  
A PARTIR DEL  
1 DE MAYO

Ref. Color

862415 ●

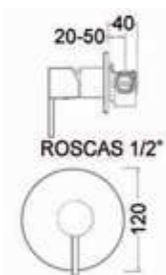

3250729

## SENA Monomando baño ducha con accesorios

Bath/shower mixer with accessories | Mitigeur bain-douche avec accessoires  
Einhebel wannen und duschmischer mit Zubehör  
Однорычажный Смеситель для ванны и душа с аксессуарами

**NEW**  
A PARTIR DEL  
1 DE MAYO

Ref. Color

868301 ●

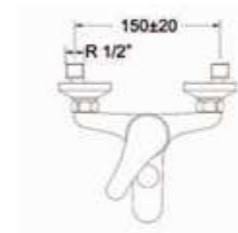

3159007



3150039



DX304E



DX109R



3250729



DX702L

## SENA Monomando empotrado baño ducha

Built-in bath/shower mixer | Mitigeur bain-douche à encastrer  
Unterputz wannen und duschmischer  
Однорычажный Смеситель встроенный ванна душ

**NEW**  
A PARTIR DEL  
1 DE MAYO

Ref. Color

862414 ●

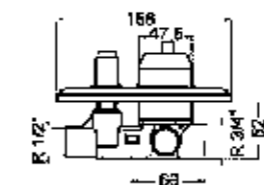

3250729



3150013



## SENA Conjunto empotrado ducha

Kit Built-in shower | Kit Mitigeur douche a encastrer  
 Kit Unterputz duschmischer  
 Комплект встраиваемого однорычажного душа

**NEW**  
 A PARTIR DEL  
 1 DE MAYO

Ref. KT8601

Empotrado ducha - 862415

Barra - DX208R

Teleducha - DX109R

Toma de agua - DX402E

Flexo - DX702L



## SENA Conjunto empotrado baño ducha

Kit Built-in shower | Kit Mitigeur douche a encastrer  
 Brause-Wand-Kit | Настенный душ комплект

**NEW**  
 A PARTIR DEL  
 1 DE MAYO

Ref. KT8602

Empotrado ducha baño - 862414

Rociador - DX001/200RE

Brazo - DX503E

Barra - DX208R

Toma de agua - DX402E

Flexo - DX702L

Teleducha - DX109R



# MADRID

Clase





## MADRID Monomando lavabo

Wash-basin mixer | Mitigeur lavabo | Einhebel waschtischmischer  
Однорычажный Смеситель для раковины

**NEW**  
A PARTIR DEL  
1 DE MAYO

Ref. Color

505101 ●

505102 CV ●

c/v: válvula clic clac

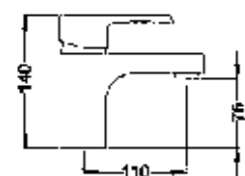

## MADRID Monomando bidé

Bidet mixer | Mitigeur bidet | Einhebel bidetmischer  
Однорычажный Смеситель для Биде

**NEW**  
A PARTIR DEL  
1 DE MAYO

Ref. Color

505201 ●

505202 CV ●

c/v: válvula clic clac

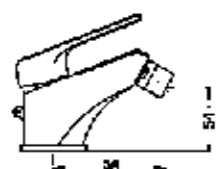

## MADRID Monomando ducha con accesorios

Shower mixer with accessories | Mitigeur douche avec accessoires  
Einhebel duschmischer mit Zubehör  
Однорычажный Смеситель для душа с аксессуарами

**NEW**  
A PARTIR DEL  
1 DE MAYO

Ref. Color

505401 ●

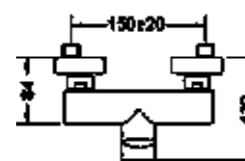

## MADRID Monomando empotrado ducha

Built-in shower mixer | Mitigeur douche à encastrer  
Unterputz duschmischer  
Однорычажный Смеситель встроенный для душа

**NEW**  
A PARTIR DEL  
1 DE MAYO

Ref. Color

502415 ●

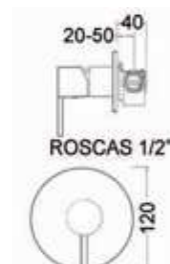

## MADRID Monomando baño ducha con accesorios

Bath/shower mixer with accessories | Mitigeur bain-douche avec accessoires  
Einhebel wannen und duschmischer mit Zubehör  
Однорычажный Смеситель для ванны и душа с аксессуарами

**NEW**  
A PARTIR DEL  
1 DE MAYO

Ref. Color

505301 ●

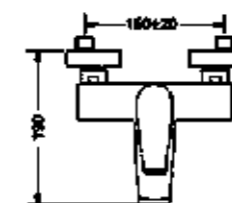

## MADRID Monomando empotrado baño ducha

Built-in bath/shower mixer | Mitigeur bain-douche à encastrer  
Unterputz wannen und duschmischer  
Однорычажный Смеситель встроенный ванна душ

**NEW**  
A PARTIR DEL  
1 DE MAYO

Ref. Color

502414 ●

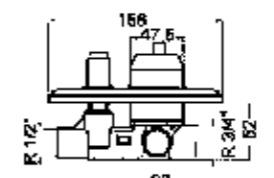

## MADRID Conjunto empotrado ducha

Kit built-in shower | Kit Mitigeur douche a encastrer  
 Kit Unterputz duschmischer  
 Комплект встраиваемого однорычажного душа

**NEW**  
 A PARTIR DEL  
 1 DE MAYO

Ref. KT5001

Empotrado ducha - 502415

Barra - DX203R

Toma de agua - DX402R

Teleducha - DX105R

Flexo - DX702L



## MADRID Conjunto empotrado baño ducha

Kit built-in shower | Kit Mitigeur douche a encastrer  
 Brause-Wand-Kit | Настенный душ комплект

**NEW**  
 A PARTIR DEL  
 1 DE MAYO

Ref. KT5002

Empotrado ducha baño - 502414

Rociador - DX001/200RE

Brazo - DX503E

Barra - DX203R

Toma de agua - DX402R

Flexo - DX702L

Teleducha - DX105R



**ARTE**  
Buen gusto



## ARTE Monomando lavabo

Wash-basin mixer | Mitigeur lavabo | Einhebel waschtischmischer  
Однорычажный Смеситель для раковины

Ref. Color

687101 ●

687102 *cv* ●

*c/v: válvula clic clac*

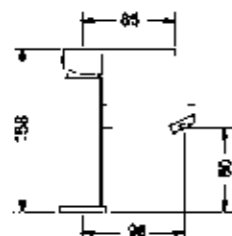

## ARTE Monomando bidé

Bidet mixer | Mitigeur bidet | Einhebel bidetmischer | Однорычажный Смеситель для Биде

Ref. Color

687201 ●

687202 *cv* ●

*c/v: válvula clic clac*

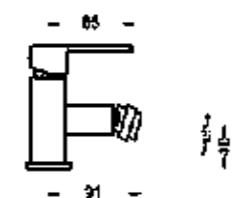

## ARTE Monomando ducha con accesorios

Shower mixer with accessories | Mitigeur douche avec accessoires  
Einhebel duschmischer mit Zubehör | Однорычажный Смеситель для душа с аксессуарами

Ref. Color

687401 ●

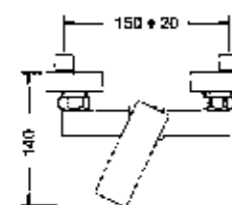

## ARTE Monomando empotrado ducha

Built-in shower mixer | Mitigeur douche à encastrer  
Unterputz duschmischer | Однорычажный Смеситель встроенный для душа

Ref. Color

680102 ●

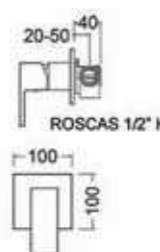

## ARTE Monomando baño ducha con accesorios

Bath/shower mixer with accessories | Mitigeur bain-douche avec accessoires  
Einhebel wannen und duschmischer mit Zubehör  
Однорычажный Смеситель для ванны и душа с аксессуарами

Ref. Color

687301 ●

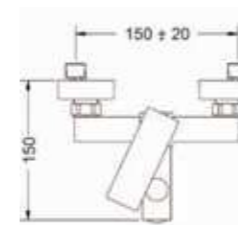

## ARTE Monomando empotrado baño ducha

Built-in bath/shower mixer | Mitigeur bain-douche à encastrer  
Unterputz wannen und duschmischer | Однорычажный Смеситель встроенный ванна душ

Ref. Color

680105 ●

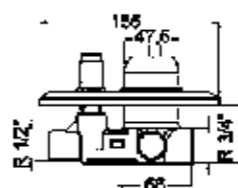

## ARTE Conjunto empotrado ducha

Kit built-in shower | Kit Mitigeur douche a encastrer | Kit Unterputz duschmischer  
Комплект встраиваемого однорычажного душа

Ref. KT6804

Empotrado ducha - 680102

Rociador - DX002/200E

Brazo - DX503R



## ARTE Conjunto empotrado baño ducha

Kit built-in shower | Kit Mitigeur douche a encastrer  
Brause-Wand-Kit | Настенный душ комплект

Ref. KT6805

Empotrado ducha baño - 680105

Rociador - DX002/200E

Brazo - DX503R

Barra - DX205R

Toma de agua - DX401C

Flexo - DX702L

Teleducha - DX103C



**CC1**

El más imitado del mundo



## CC1 Monomando lavabo

Wash-basin mixer | Mitigeur lavabo | Einhebel waschtischmischer  
Однорычажный Смеситель для раковины

Ref. Color

422101 ●

422102 CV ●

c/v: válvula clic clac

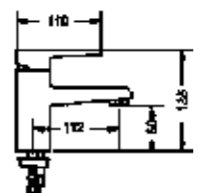

DX803E

3159007

3250727

## CC1 Monomando lavabo alto

High wash-basin mixer | Mitigeur lavabo haut  
Einhebel waschtischmischer. Hohemn ausführung  
Смеситель для раковины высокий

**NEW**  
A PARTIR DEL  
1 DE MAYO

Ref. Color

422111 ●

422112 CV ●

c/v: válvula clic clac

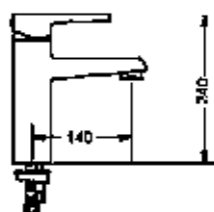

DX803E

3159007

3250727

## CC1 Monomando bidé

Bidet mixer | Mitigeur bidet | Einhebel bidetmischer | Однорычажный Смеситель для Биде

Ref. Color

422201 ●

422202 CV ●

c/v: válvula clic clac

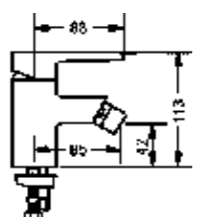

DX803E

3159027

3250727

## CC1 Monomando ducha con accesorios

Shower mixer with accessories | Mitigeur douche avec accessoires  
Einhebel duschmischer mit Zubehör  
Однорычажный Смеситель для ванны и душа с аксессуарами

Ref. Color

422401 ●

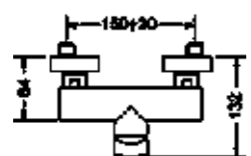

DX702L

DX304E

DX105R

3250727

## CC1 Monomando empotrado ducha

Built-in shower mixer | Mitigeur douche à encastrer  
Unterputz duschmischer | Однорычажный Смеситель встроенный для душа

Ref. Color

422415 ●

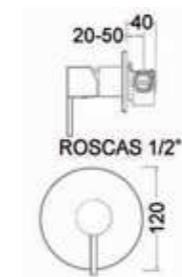

3250727

## CC1 Monomando baño ducha con accesorios

Bath/shower mixer with accessories | Mitigeur bain-douche avec accessoires  
Einhebel wannen und duschmischer mit Zubehör  
Однорычажный Смеситель для ванны и душа с аксессуарами

Ref. Color

422301 ●

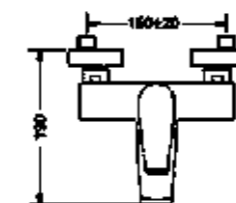

3159007

3150006

DX304E

DX105R

3250727

DX702L

## CC1 Monomando empotrar baño ducha

Built-in bath/shower mixer | Mitigeur bain-douche à encastrer  
Unterputz wannen und duschmischer | Однорычажный Смеситель встроенный ванна душ

Ref. Color

422414 ●

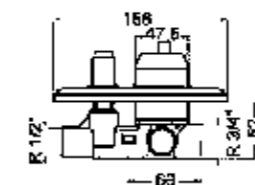

3250727

3150013



CC1 Conjunto empotrado ducha

Kit built-in shower | Kit Mitigeur douche a encastrer | Kit Unterputz duschmischer  
Комплект встраиваемого одно рычажного душа

Ref. KT4201

Empotrado ducha - 422415

Barra - DX203R

Toma de agua - DX402R

Teleducha - DX105R

Flexo - DX702L



CC1 Conjunto empotrado baño ducha

Kit built-in shower | Kit Mitigeur douche a encastrer  
Brause-Wand-Kit | Настенный душ комплект

Ref. KT4202

Empotrado ducha baño - 422414

Rociador - DX001/200RE

Brazo - DX503R

Barra - DX203R

Toma de agua - DX402R

Flexo - DX702L

Teleducha - DX105R





# GRANADA

Embrujo



## GRANADA Monomando lavabo

Wash-basin mixer | Mitigeur lavabo | Einhebel waschtischmischer  
Однорычажный Смеситель для раковины

Ref. Color

668101 ●

668102 CV ●

c/v: válvula clic clac

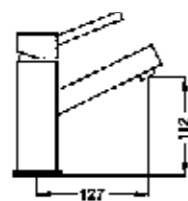

## GRANADA Monomando lavabo alto

High wash-basin mixer | Mitigeur lavabo haut | Einhebel waschtischmischer. Hohemn ausführung  
Однорычажный Смеситель для раковин высокий

Ref. Color

668111 ●

668112 CV ●

c/v: válvula clic clac

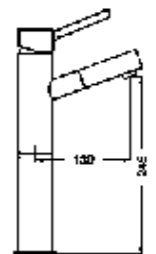

## GRANADA Monomando lavabo empotrado

Built-in single-lever wash-basin mixer | Mitigeur lavabo mural à encastrer  
Unterputz Einhebel wannenmischer | Однорычажный Смеситель для раковины встроенный

Ref. Color

668108/16 ●

668108/22 ●

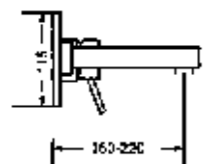

## GRANADA Monomando bidé

Bidet mixer | Mitigeur bidet | Einhebel bidetmischer | Однорычажный Смеситель для Биде

Ref. Color

668201 ●

668202 ●

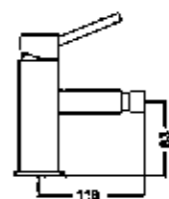

## GRANADA Monomando ducha con accesorios

Shower mixer with accessories | Mitigeur douche avec accessoires  
Einhebel duschmischer mit Zubehör | Однорычажный Смеситель для душа с аксессуарами

Ref. Color

668401 ●



## GRANADA Monomando empotrado ducha

Built-in shower mixer | Mitigeur douche à encastrer | Unterputz duschmischer  
Однорычажный Смеситель встроенный для душа

Ref. Color

662415 ●

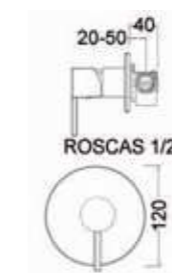

## GRANADA Monomando baño ducha con accesorios

Bath/shower mixer with accessories | Mitigeur bain-douche avec accessoires  
Einhebel wannen und duschmischer mit Zubehör | Однорычажный Смеситель для ванны и душа с аксессуарами

Ref. Color

668301 ●

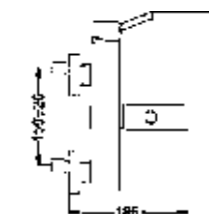

## GRANADA Monomando empotrado baño ducha

Built-in bath/shower mixer | Mitigeur bain-douche à encastrer  
Unterputz wannen und duschmischer | Однорычажный Смеситель встроенный ванна душ

Ref. Color

662414 ●

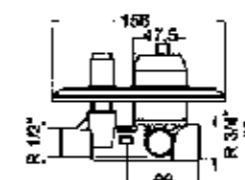

## GRANADA Conjunto empotrado ducha

Kit built-in shower | Kit Mitigeur douche a encastrer | Kit Unterputz duschmischer  
Комплект встраиваемого одно рычажного душа

Ref. KT6601

Empotrado ducha - 662415

Barra - DX208R

Toma de agua - DX402R

Teleducha - DX104R

Flexo - DX702L



## GRANADA Conjunto empotrado baño ducha

Kit built-in shower | Kit Mitigeur douche a encastrer  
Brause-Wand-Kit | Настенный душ комплект

Ref. KT6602

Empotrado ducha baño - 662414

Rociador - DX001/200RE

Brazo - DX503E

Barra - DX208R

Toma de agua - DX402R

Flexo - DX702L

Teleducha - DX104R



**ON**  
Vital



ON Monomando lavabo

Wash-basin mixer | Mitigeur lavabo | Einhebel waschtischmischer  
Однорычажный Смеситель для раковины

NEW

Ref. Color

553101 ●

553102 CV ●

c/v: válvula clic clac

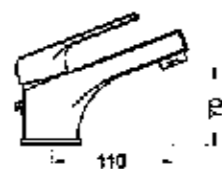

ON Monomando bidé

Bidet mixer | Mitigeur bidet | Einhebel bidetmischer  
Однорычажный Смеситель для Биде

NEW

Ref. Color

553201 ●

553202 CV ●

c/v: válvula clic clac

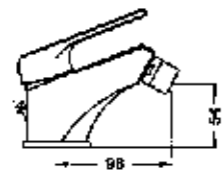

ON Monomando ducha con accesorios

Shower mixer with accessories | Mitigeur douche avec accessoires  
Einhebel duschmischer mit Zubehör  
Однорычажный Смеситель для душа с аксессуарами

NEW

Ref. Color

553401 ●

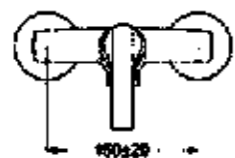

ON Monomando empotrado ducha

Built-in shower mixer | Mitigeur douche à encastrer  
Unterputz duschmischer  
Однорычажный Смеситель встроенный для душа

NEW

Ref. Color

552415 ●

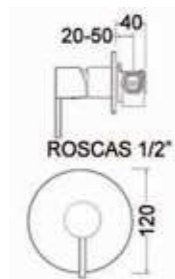

ON Monomando baño ducha con accesorios

Bath/shower mixer with accessories | Mitigeur bain-douche avec accessoires  
Einhebel wannen und duschmischer mit Zubehör  
Однорычажный Смеситель для ванны и душа с аксессуарами

NEW

Ref. Color

553301 ●

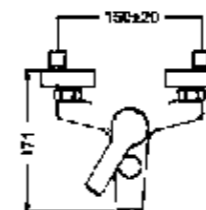

ON Monomando empotrado baño ducha

Built-in bath/shower mixer | Mitigeur bain-douche à encastrer  
Unterputz wannen und duschmischer  
Однорычажный Смеситель встроенный ванна душ

NEW

Ref. Color

552414 ●

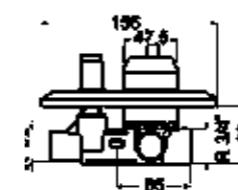

ON Conjunto empotrado ducha

Kit built-in shower | Kit Mitigeur douche a encastrer  
 Kit Unterputz duschmischer  
 Комплект встраиваемого однорычажного душа

NEW

Ref. KT5501

Empotrado ducha - 552415

Barra - DX208R

Toma de agua - DX402E

Teleducha - DX109R

Flexo - DX702L



ON Conjunto empotrado baño ducha

Kit built-in shower | Kit Mitigeur douche a encastrer  
 Brause-Wand-Kit | Настенный душ комплект

NEW

Ref. KT5502

Empotrado ducha baño - 552414

Rociador - DX001/200RE

Brazo - DX503E

Barra - DX208R

Toma de agua - DX402E

Flexo - DX702L

Teleducha - DX109R



# AKTIVA

Ingenio



## AKTIVA Monomando lavabo

Wash-basin mixer | Mitigeur lavabo | Einhebel waschtischmischer  
Однорычажный Смеситель для раковины

**NEW**

Ref. Color

848101 ●

848102 *cv* ●

*cv*: válvula clic clac

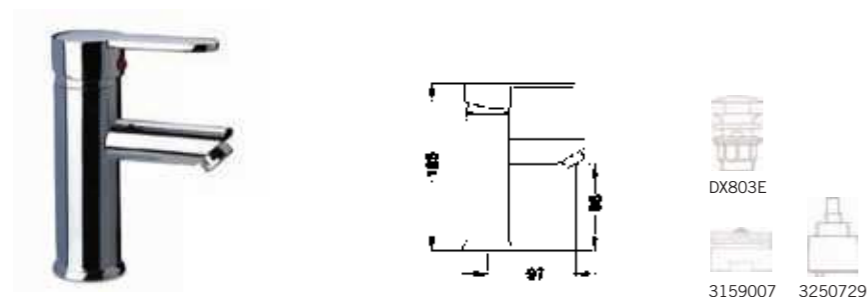

## AKTIVA Monomando lavabo alto

High wash-basin mixer | Mitigeur lavabo haut | Einhebel waschtischmischer.  
Hohemn ausführung | Однорычажный Смеситель для раковин высокий

**NEW**

Ref. Color

848111 ●

848112 *cv* ●

*cv*: válvula clic clac

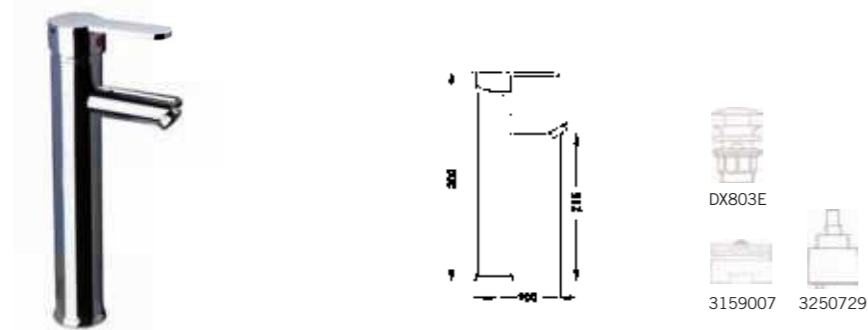

## AKTIVA Monomando bidé

Bidet mixer | Mitigeur bidet | Einhebel bidetmischer  
Однорычажный Смеситель для Биде

**NEW**

Ref. Color

848201 ●

848202 *cv* ●

*cv*: válvula clic clac

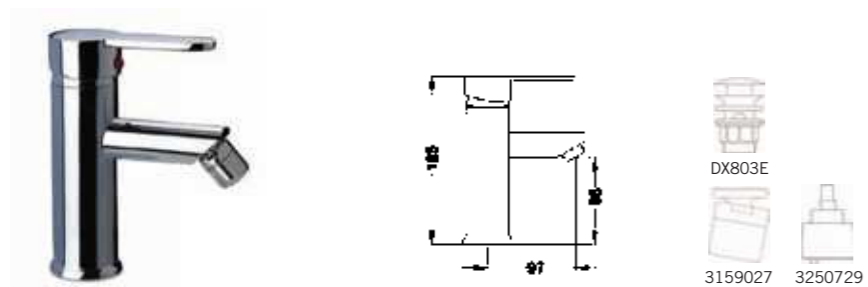

## AKTIVA Monomando ducha con accesorios

Shower mixer with accessories | Mitigeur douche avec accessoires  
Einhebel duschmischer mit Zubehör  
Однорычажный Смеситель для ванны и душа с аксессуарами

**NEW**

Ref. Color

848401 ●

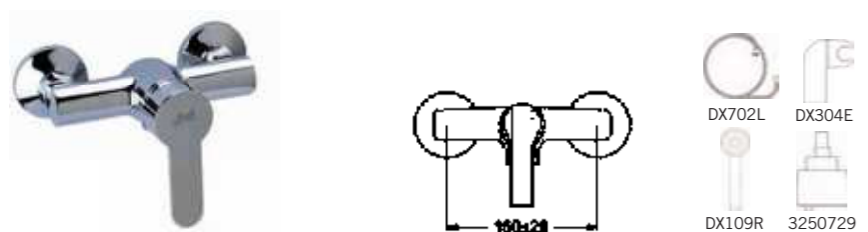

## AKTIVA Monomando empotrado ducha

Built-in shower mixer | Mitigeur douche à encastrer  
Unterputz duschmischer | Однорычажный Смеситель встроенный для душа

**NEW**

Ref. Color

842415 ●

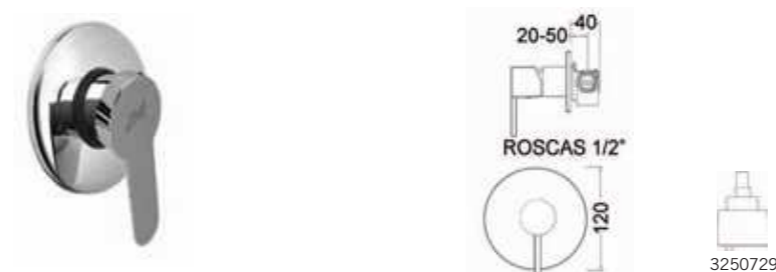

## AKTIVA Monomando baño ducha con accesorios

Bath/shower mixer with accessories | Mitigeur bain-douche avec accessoires  
Einhebel wannen und duschmischer mit Zubehör  
Однорычажный Смеситель для ванны и душа с аксессуарами

**NEW**

Ref. Color

848301 ●



## AKTIVA Monomando empotrar baño ducha

Built-in bath/shower mixer | Mitigeur bain-douche à encastrer  
Unterputz wannen und duschmischer  
Однорычажный Смеситель встроенный ванна душ

**NEW**

Ref. Color

842414 ●

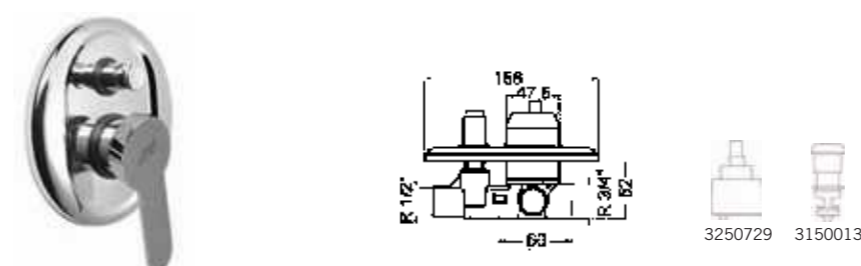



## AKTIVA Conjunto empotrado ducha

Kit built-in shower | Kit Mitigeur douche a encastrer  
 Kit Unterputz duschmischer  
 Комплект встраиваемого одно рычажного душа

**NEW**

Ref. KT8401

Empotrado ducha - 842415

Barra - DX208R

Toma de agua - DX402E

Teleducha - DX109R

Flexo - DX702L



## AKTIVA Conjunto empotrado baño ducha

Kit built-in shower | Kit Mitigeur douche a encastrer  
 Brause-Wand-Kit | Настенный душ комплект

**NEW**

Ref. KT8402

Empotrado ducha baño - 842414

Rociador - DX001/200RE

Brazo - DX503E

Barra - DX208R

Toma de agua - DX402E

Flexo - DX702L

Teleducha - DX109R



# RIALTO

Clásico



## RIALTO Monomando lavabo

Wash-basin mixer | Mitigeur lavabo | Einhebel waschtischmischer  
Однорычажный Смеситель для раковины

Ref. Color

824101 ●

824102 *cv* ●

*cv*: válvula clic clac



## RIALTO Monomando lavabo con flexo

Wash-basin mixer with hose | Mitigeur lavabo avec flexible | Einhebel waschtischmischer  
Однорычажный Смеситель для раковины

Ref. Color

820308 ●

820309 *cv* ●

*cv*: válvula clic clac

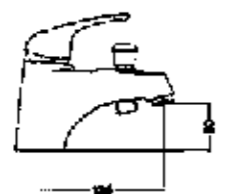

## RIALTO Monomando bidé

Bidet mixer | Mitigeur bidet | Einhebel bidetmischer  
Однорычажный Смеситель для Биде

Ref. Color

824201 ●

824202 *cv* ●

*cv*: válvula clic clac

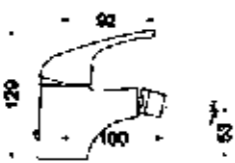

## RIALTO Monomando ducha con accesorios

Shower mixer with accessories | Mitigeur douche avec accessoires  
Einhebel duschmischer mit Zubehör | Однорычажный Смеситель для душа с аксессуарами

Ref. Color

824401 ●

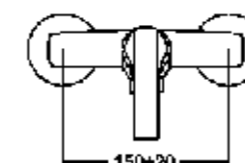

## RIALTO Monomando empotrado ducha

Built-in shower mixer | Mitigeur douche à encastrer | Unterputz duschmischer  
Однорычажный Смеситель встроенный для душа

Ref. Color

822415 ●



## RIALTO Monomando empotrado baño ducha

Built-in bath/shower mixer | Mitigeur bain-douche à encastrer | Unterputz wannen und duschmischer  
Однорычажный Смеситель встроенный ванна душ

Ref. Color

822414 ●

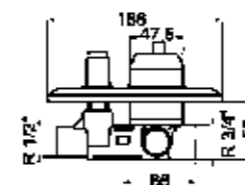

## RIALTO Monomando baño ducha con accesorios

Bath/shower mixer with accessories | Mitigeur bain-douche avec accessoires  
Einhebel wannen und duschmischer mit Zubehör | Однорычажный Смеситель для ванны и душа с аксессуарами

Ref. Color

824301 ●

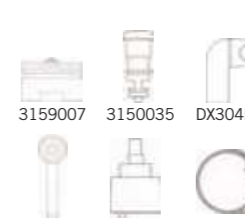
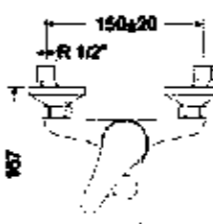

## RIALTO Conjunto empotrado ducha

Kit built-in shower | Kit Mitigeur douche a encastrer | Kit Unterputz duschmischer  
Комплект встраиваемого одно рычажного душа

Ref. KT8201

Empotrado ducha - 822415

Rociador - DX001/200RE

Brazo - DX503E



## RIALTO Conjunto empotrado baño ducha

Kit built-in shower | Kit Mitigeur douche a encastrer  
Brause-Wand-Kit | Настенный душ комплект

Ref. KT8202

Empotrado ducha baño - 822414

Rociador - DX001/200RE

Brazo - DX503E

Barra - DX208R

Toma de agua - DX402E

Flexo - DX702L

Teleducha - DX109R



# PARIS

Oh la la!



## PARIS Grifo de lavabo 1/2"

Wash basin tap 1/2" | Robinet lavabo 1/2" | Standventil 1/2"  
Смеситель для умывальника 1/2"

Ref. Color

601006 ●

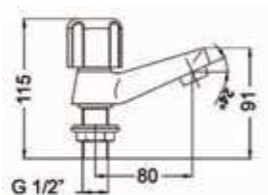

3159007 3240706



## PARIS Monobloc lavabo

Monobloc wash-basin | Mélangeur lavabo | Waschtischbatterie  
Смеситель для раковины

Ref. Color

601004 ●

601049 *cv* ●

*cv*: válvula clic clac

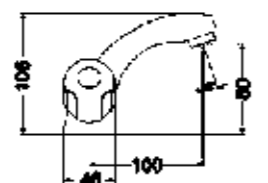

DX803E  
3159007 3240706



## PARIS Monobloc bidé

Single-hole bidet | Mélangeur bidet | Bidetbatterie | Смеситель для Биде

Ref. Color

602508 ●

602514 *cv* ●

*cv*: válvula clic clac

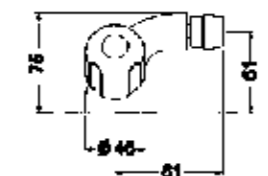

DX803E  
3159030 3240706



## PARIS Batería baño ducha con accesorios

Bath/shower mixer with accessories | Mélangeur bain-douche au mur, avec accessoires  
Wannen und dusch batterie mit zuberhör | Набор ванна душ с аксессуарами

Ref. Color

603519 ●

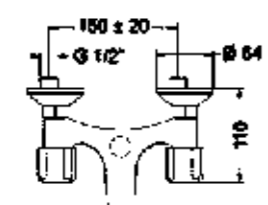

3159006 3150006 DX304E  
DX109R 3240706 DX702L



## PARIS Batería ducha monobloc con accesorios

Shower mixer with accessories | Mélangeur douche avec accessoires  
Dusch batterie mit zuberhör | смеситель для душа с аксессуарами

Ref. Color

605100 ●

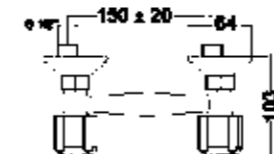

3240706 DX109R  
DX304E DX702L



## PARIS Grifo mural 1 agua

Wall faucet | Robinet mural | Wandarmatur | смеситель

Ref. Color

605003 ●

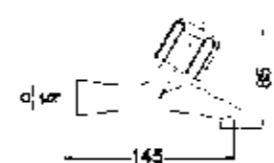

3159007 3240706



## PARIS Grifo mural 1 agua

Wall faucet | Robinet mural | Wandarmatur | смеситель

Ref. Color

605004 ●

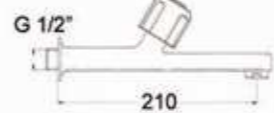

3159007 3240706



## PARIS Grifo lavadora sencillo/doble

Tap washer | Robinet laveuse | Spültischarmatur Waschmaschine | смеситель для стиральная машина  
Washer faucet, two outputs | Robinet-vaisselle, deux sorties  
Spültischarmatur Waschmaschine zwei Ausgänge | смеситель для машина, два выхода

Ref. Color

<sup>1</sup> 605006 ●

<sup>2</sup> 605007 ●

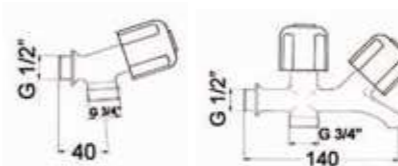

3159007 3240706

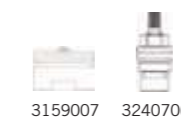

# TEMPORIZADOS

Comodidad y control



# TEMPORIZADOS

## TEMPORIZADOS Grifo temporizado

Timed washbasin tap | Robinet de lavabo temporisé  
Timed Waschtischarmatur | Смеситель для раковины с таймером воды

Ref. 301000  
Color ●



## TEMPORIZADOS Grifo temporizado a pared

Wall faucet | Robinet mural | Wandarmatur | Смеситель для раковины с таймером воды

Ref. 302000  
Color ●

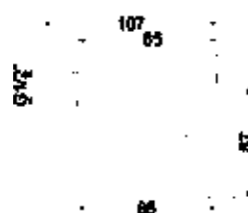

## TEMPORIZADOS Grifo lavabo temporizado mezclador agua fría/caliente

Timed washbasin tap | Robinet de lavabo temporisé | Timed Waschtischarmatur  
Смеситель для раковины с таймером (смешивание), 2 подвода воды

Ref. 307000  
Color ●

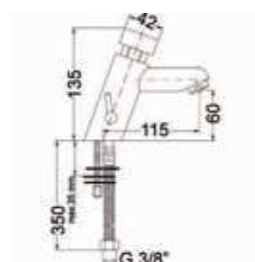

## TEMPORIZADOS Grifo urinario temporizado

Timed urinary Faucet | Robinet urinaire temporisé  
Timed Harn-Wasserhahn | Смеситель для писсуара с таймером

Ref. 304000  
Color ●

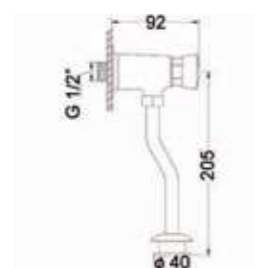

## TEMPORIZADOS Grifería empotrada de ducha temporizada

Timed mixer for shower | Robinet temporisé de douche  
Timed Wasserhahn Dusche | Встраиваемый смеситель для душа с таймером

Ref. 305000  
Color ●

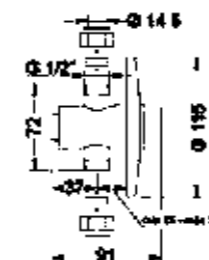



# ELECTRÓNICOS

Modernidad a tu alcance



# ELECTRÓNICOS

## ELECTRÓNICOS Grifo lavabo electrónico 1 agua

Electronic 1 water tap | Robinet électronique 1 eau  
Elektronische Wasserhahn ein Wasser | электронный смеситель для раковины

Ref. Color

511555 ●

\*Funcionamiento con 4 pilas AA



## ELECTRÓNICOS Grifo lavabo electrónico 1 agua

Electronic 1 water tap | Robinet électronique 1 eau  
Elektronische Wasserhahn ein Wasser | электронный смеситель для раковины

Ref. Color

511550 ●

\*Funcionamiento con 4 pilas AA



## TEMPORIZADOS Grifo lavabo electrónico mezclador 2 aguas

Electronic 2 water tap | Robinet électronique 2 eau  
Elektronische Wasserhahn 2 Wasser  
Смеситель для раковины с электронный, 2 подвода воды

Ref. Color

511551 ●

\*Funcionamiento con 4 pilas AAA

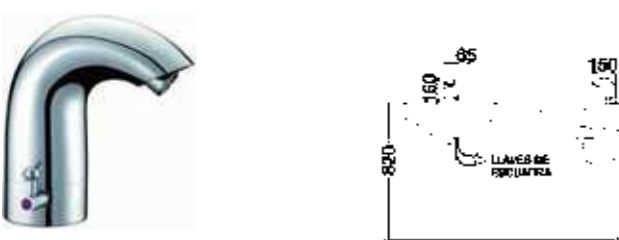

## ELECTRÓNICOS Grifo urinario empotrado electrónico

Electronic faucet, urinal | Robinet électronique, urinoir  
Elektronische Wasserhahn, Urinal | Встроенный смеситель для писсуара электронный

Ref. Color

511520 ●

\*Funcionamiento con 4 pilas AA



## ELECTRÓNICOS Grifo urinario electrónico

Electronic faucet, urinal | Robinet électronique, urinoir  
Elektronische Wasserhahn, Urinal | Смеситель для писсуара электронный

Ref. Color

511521 ●

\*Funcionamiento con 4 pilas AAA

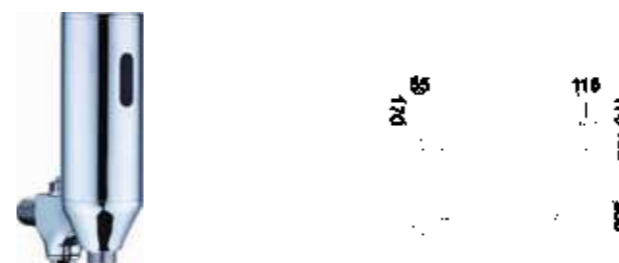

# TERMOSTÁTICOS

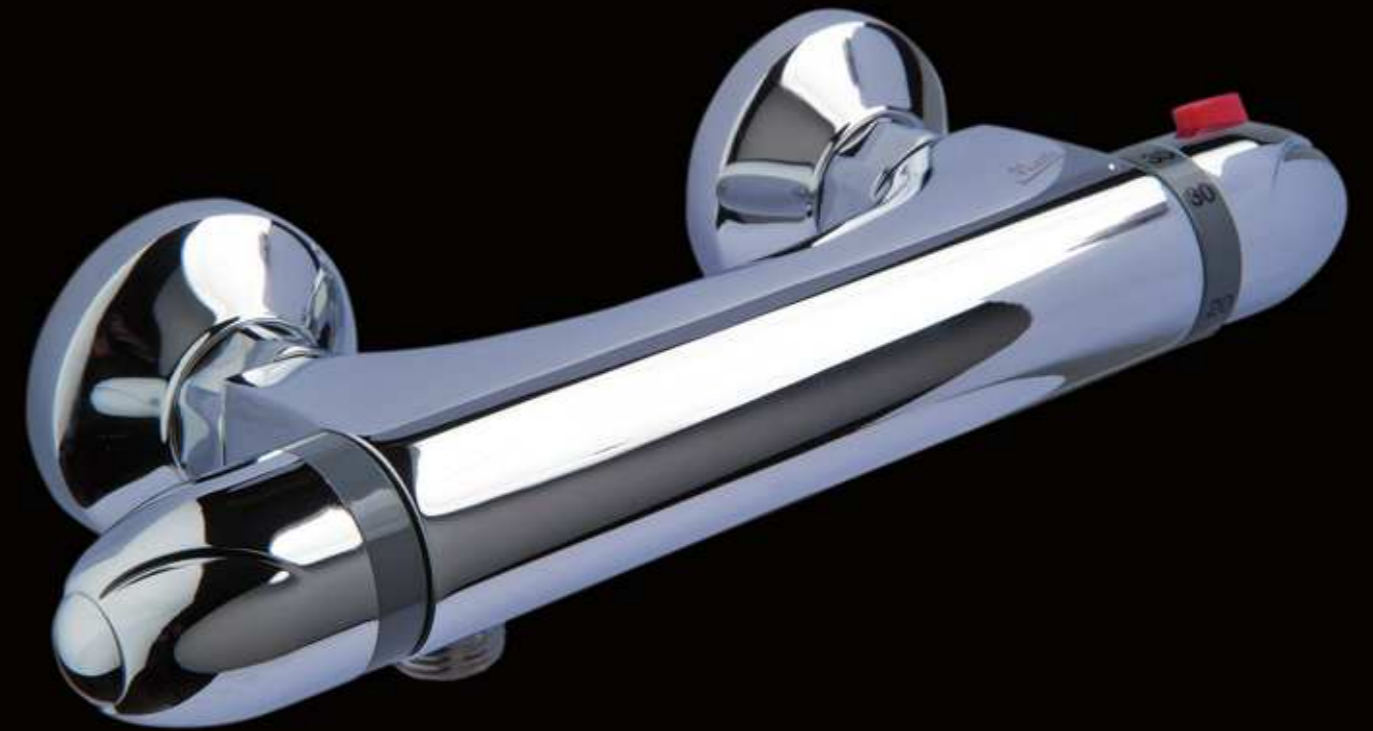

# TERMOSTÁTICOS

## Termostático Baño ducha

Thermostatic bath/shower | Thermostatique bain douche | Thermostat-Bad-Dusche  
Наружный смеситель с термостатом для ванны/душа без аксессуаров

Ref.

Color

192033R

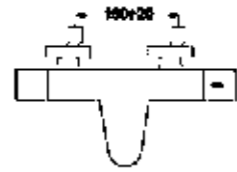

3240712



3250736

## Termostático de ducha

Thermostatic shower | Douche thermostatique | Thermostat-Brause  
Наружный смеситель с термостатом для душа без аксессуаров

Ref.

Color

192035R

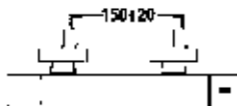

3240712

## Termostático Baño ducha

Thermostatic bath/shower | Thermostatique bain douche | Thermostat-Bad-Dusche  
Наружный смеситель с термостатом для ванны/душа без аксессуаров

Ref.

Color

TE13095R

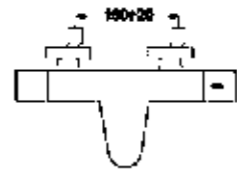

3240712



3250737

## Termostático de ducha

Thermostatic shower | Douche thermostatique | Thermostat-Brause  
Наружный смеситель с термостатом для душа без аксессуаров

Ref.

Color

TE13090R

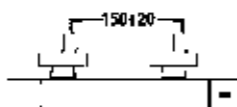

3240712



3250737

## Termostático de ducha

Thermostatic shower | Douche thermostatique | Thermostat-Brause  
Наружный смеситель с термостатом для душа без аксессуаров

Ref.

Color

M1T0104

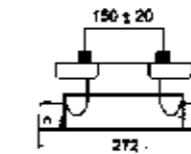

3240712



3250736

## Termostático Baño ducha

Thermostatic bath/shower | Thermostatique bain douche | Thermostat-Bad-Dusche  
Наружный смеситель с термостатом для душа без аксессуаров

Ref.

Color

M1T0204

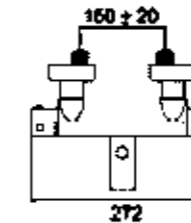

3240712



3250736



MARTÍ 1921 les aconseja:

1. Purgar las tuberías y limpiarlas cuidadosamente para eliminar impurezas y depósitos.
2. Montar las excéntricas en las tuberías (rosca 1/2”).
3. Enroscar los dos embellecedores sobre las excéntricas.
4. Fijar el grifo termostático usando las tuercas, colocando antes las juntas de 3/4” con filtro orientado hacia la tubería.

Todos nuestros grifos termostaticos van provistos de valvulas antiretorno para evitar, que en fria y caliente, el agua se mezcle en la instalacion.

Todos nuestros grifos termostaticos salen de fabrica, probados y calibrados. En condiciones de uso normal e instalación adecuada no tiene porque presentarse ningún problema, en cambio si no se observan las normas de instalación basicas, pueden producirse ciertas anomalias.

PROBLEMA	POSIBLE CAUSAS	SOLUCIÓN
- Grifo termostático gotea o no cierra.	- Cierre cerámico roto o sucio.	- Cambie el cierre cerámico o límpielo.
- No se puede pasar la maneta de 38c. - No se consigue otra temperatura.	- Tope de seguridad.	- Deslice o pulse el tope de seguridad de la maneta.
- El agua sale muy caliente o muy fría y no se tiene temperatura intermedia.	- Seguramente el agua fría y caliente - Estén invertidas. - Toque el grifo para verificar, la caliente debe ser la izquierda.	- Invierta las tuberías.
- No sale agua caliente o sale poco caudal	- No hay caldera o calentador. - Filtros atascados. - Cartucho termostático sucio.	- Instale una caldera o calentador. - Corte el agua y retire el grifo para limpiarlos. - Limpie el cartucho.
- El agua sale fría y caliente de manera alternativa o el calentador se enciende y apaga intermitentemente. - El agua sólo sale templada incluso en la posición de todo caliente, aunque con mucho caudal.	- Suele darse en verano. - La caldera no arranca porque no hay suficiente demanda de caudal. - Puede darse en invierno. - La caldera no tiene suficiente potencia.	- Baje un poco la temperatura de la caldera o abra el grifo completamente. - Instale un mango de ducha con mucho caudal. - Cierre un poco el grifo. - Instale un mango de ducha con poco caudal o un limitador de caudal ecosystem.
- No sale agua o sólo sale un hilo de agua.	- Una de las alimentaciones está cortada.	- Compruebe girando el mando de la temperatura a los dos extremos. - Si en uno hay caudal, una alimentación está cortada. Revise la instalación.

MARTI 1921 recomienda el uso de sus excéntricas con filtro para proteger a su termostática.

El tiempo de reacción del cartucho termostático es de 1 segundo, variando los caudales de entrada para restablecer la temperatura programada.

PRESION DE TRABAJO IDEAL 3 BAR

PRESION DE TRABAJO 2-5 BAR

DIFERENCIA DE PRESION MAXIMA AGUA FRIA Y CALIENTE 0,5 BAR

MARTÍ 1921 advises you:

1. Flush the pipes and clean thoroughly to remove dirt and deposits.
2. Assemble the eccentric in the pipes (thread 1/2 “).
3. Screw the two trims on the eccentric.
4. Fix the thermostatic valve using the nuts, placing first the 3/4 “ joints with the filter oriented toward the pipe.

All our thermostatic taps are fitted with valves to prevent backflow, which avoid that in cold and hot, the water get mixed in the installation.

All our taps come out from the factory tested and calibrated. In normal conditions of using and proper installing, there is no reason for having any problem, but if the basic norms for installation are not taken in consideration, there might be some anomalies.

PROBLEM	POSSIBLE CAUSE	SOLUTION
- The thermostatic tap leaks, or don't close.	- The thermostatic ceramic closing is dirty.	- Clean the thermostatic ceramic closing, or replace it.
- The handle cannot pass from 38°. - There cannot be reached another temperature.	- Safety top.	- Slide or press the top safety of the handle.
- The water is very hot or very cold and there is no intermedium temperature.	- Surely, the cold and the hot water. - Are reverted. Touch the tap to check it. - The hot water should be on the left side.	- Revert the pipes.
- There is no hot water or there is low water flow.	- There is no boiler or heater. - Stucked filters. - Dirty thermostatic cartridge.	- Install a boiler or heater. - Stop the water supply and remove the filter for cleaning. - Clean the cartridge.
- The water comes out hot or cold alternatively, or the heater turns on and off intermittently. - The water comes out only warm even in the hot position.	- It may happen in summer. - The boiler don't turn on because there is not enough water flow demand. - It may happen in summer. - The boiler don't have enough power.	- Reduce the temperature of the boiler or open the mixer completely. - Install a hand shower with high water flow. - Close the mixer a little. - Install a hand shower with low water flow or a flow limiter ecosystem.
- Even with high water flow, the water don't come out. - Or there only comes out a small quantity.	- One of the supplies is cut off.	- Check turning the temperature control to both extremes. - If in one of them, there is flow, then the supply is cut off. Check the installation.

MARTI 1921 recommends the use of its eccentric filter to protect your thermostatic.

The reaction time of the thermostatic cartridge is 1 second, varying the input flow to reset the temperature.

IDEAL WORKING PRESSURE 3 BAR

WORKING PRESSURE 2-5 BAR

MAXIMUM PRESSURE DIFFERENCE OF HOT AND COLD WATER BAR 0.5

MARTÍ 1921 vous conseille:

1. Vidanger les canalisations et soigneusement nettoyer pour en éliminer les impuretés et les dépôts.
2. Monter les exentriques dans les tuyaux (filetage 1/2 ").
3. Torsioner les florons sur les deux excentriques.
4. Fixer le robinet thermostatiques en utilisant les écrous de fixation, et placer avant des joints de 3/4 "avec filtre à l'intérieur de ceux-ci. La sortie du filtre doit être orienté vers le tuyau.

LE PROBLÈME	LES CAUSES	LES SOLUTIONS
- Le robinet thermostatique égoutte ou ne ferme pas.	- Fermeture en céramique déchiré ou souillé.	- Nettoyer ou changer la fermeteur céramique.
- Il n'est pas possible passer la poignée de 38c. - Pas disponible d'autres temperatures.	- Top de sécurité.	- Glisser ou pulser le top de sécurité de la poignée.
- L'eau est très chaude ou très froide et il n'y a pas une temperature intermédiaire.	- Sûrement les eau froide et chaude sont. - Inversés. Touche le robinet pour vérifier. - L'eau chaude doit être au gauche.	- Renverser les tuyaux.
- Il n'y a pas de l'eau chaude, le débit est basse.	- Pas de chauffage ou chaudière. - Filtres encrassés. - Cartouche thermostatique souillé.	- Installer un chauffage ou chaudière. - Couper l'eau et rétirer le robinet pour le nettoyer. - Nettoyer le cartouche
- L'eau est froide et chaude de façon alternatif ou la chaudière commence clignoter. - L'eau est templée même dans la position de très chaude, mais avec beaucoup de débit.	- Se produit souvent en été. - La chaudière ne démarre pas parce que Il n'a pas demande de débit suffisant. - Se produit souvent en hiver. - La chaudière n'a pas assez de puissance.	- Réduire un peu la temperature de la chaudère ou ouvrir le robinet complètement. - Installer une douchette avec beaucoup de debit. - Fermer un peu le robinet. - Installer une douchette avec peu de débit, ou un limiteur de débit econsystem.
- Ne sorte pas de l'eau. - Ou peu débit.	- Une alimentation est coupée.	- Voir, tourner le bouton de la temperature una aux deux extrémités. - S'il y a un flux l'alimentation est coupé. Reviser l'installation

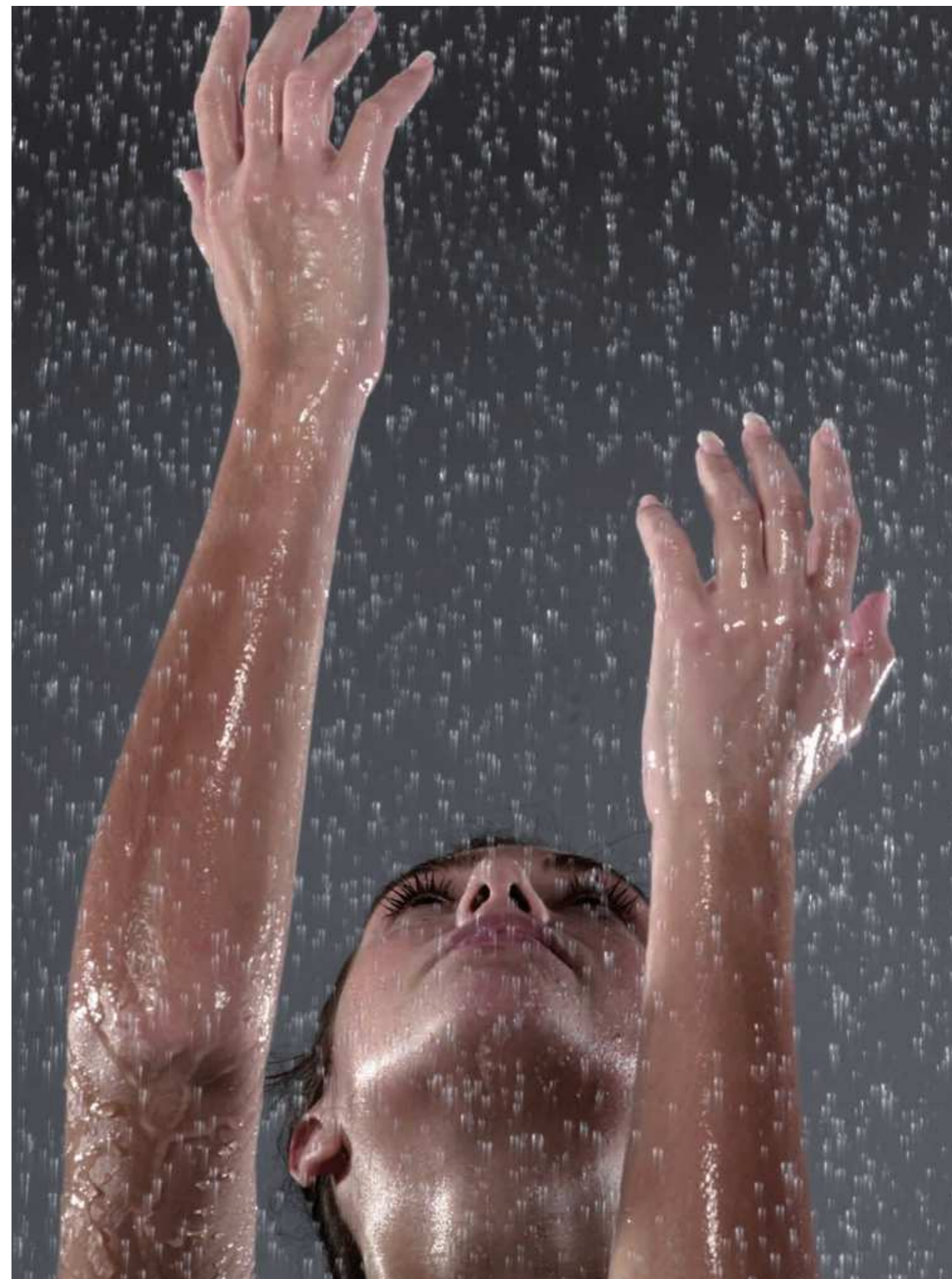

# SETS



## JAMAICA Set de ducha monomando o termostática (columna, rociador, barra y equipo)

Shower set with equipment | Set de douche colonne, avec équipement  
Набор для душа с аксессуарами

Ref. Color

TE0104C ●

TE0104CM ●

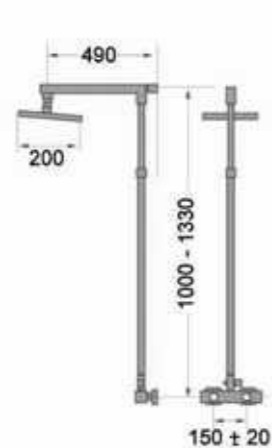

3250729



Columna Telescópica  
Telescopic columns  
Colonnes télescopiques  
Teleskopische Säulen  
Комплект встраиваемого

## CUBIC Set de grifería termostática, Columna extensible 90-120 cms Rociador y teleducha antical

Square telescopic shower column with showerhead 200 mm with diverter  
Barre de douche carré telescopique avec pomme de douche 200 mm et inverseur  
Термостатический набор для душа Включает колонну 90-120 см, верхний душ 200мм. Верхний душ и ручной душ антиизвестковые.

NEW

Ref. Color

CT1118 ●

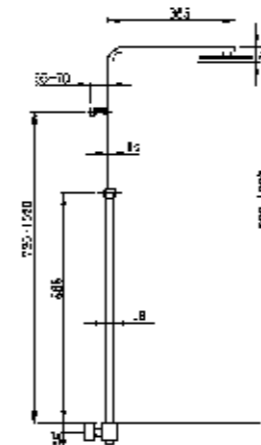

## MÉXICO Set de ducha monomando o termostática (columna, rociador, barra y equipo)

Shower set with equipment | Set de douche colonne, avec équipement  
Набор для душа с аксессуарами

Ref. Color

TE0104G ●

TE0104GM ●

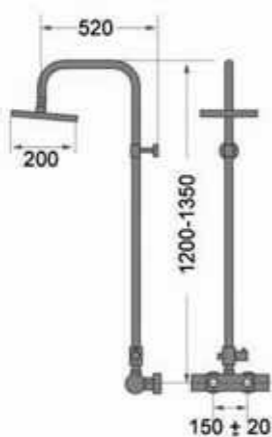

Columna Telescópica  
Telescopic columns  
Colonnes télescopiques  
Teleskopische Säulen  
Комплект встраиваемого

## MRT1 Set de grifería termostática, Columna extensible 90-120 cms Rociador y teleducha antical

Square telescopic shower column with showerhead 200 mm with diverter  
Barre de douche carré telescopique avec pomme de douche 200 mm et inverseur  
Термостатический набор для душа Включает колонну 90-120 см, верхний душ 200мм. Верхний душ и ручной душ антиизвестковые.

NEW

Ref. Color

CTM118 ●

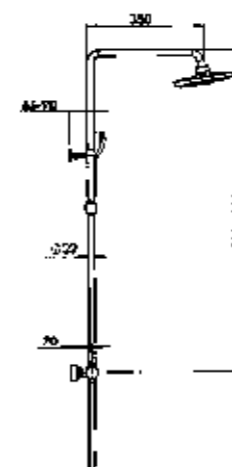



## GRANADA Set de grifería termostática, rociador y teleducha antical

Shower set with equipment | Set de douche colonne, avec équipement  
 ТЕРМОСТАТИЧЕСКИЙ НАБОР ДЛЯ ДУША. Включает колонну, верхний душ 200мм с дивертером. Верхний душ и ручной душ антиизвестковые

**NEW**

Ref. CT6118  
 Color ●

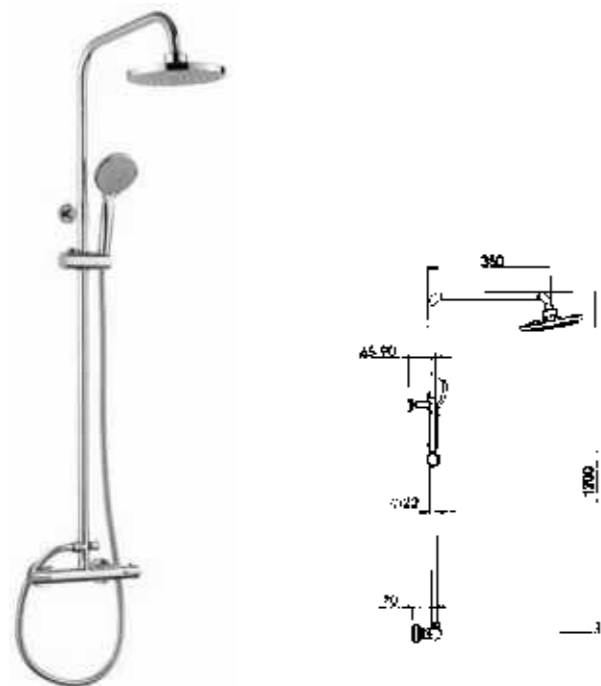

## GRANADA Set de grifería monomando, rociador y teleducha antical

Shower set with equipment | Set de douche colonne, avec équipement  
 ТЕРМОСТАТИЧЕСКИЙ НАБОР ДЛЯ ДУША. Включает колонну, верхний душ 200мм. Верхний душ и ручной душ антиизвестковые

**NEW**

Ref. 661118  
 Color ●

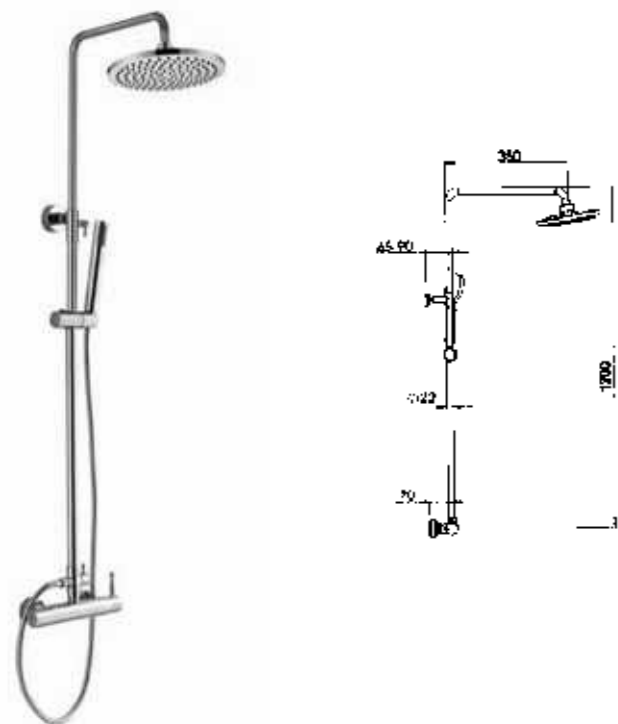

## RIALTO Set de grifería monomando, rociador y teleducha antical

Shower set with equipment | Set de douche colonne, avec équipement  
 ОДНОРЫЧАЖНЫЙ НАБОР ДЛЯ ДУША. Верхний душ и ручной душ антиизвестковые

Ref. 824118  
 Color ●

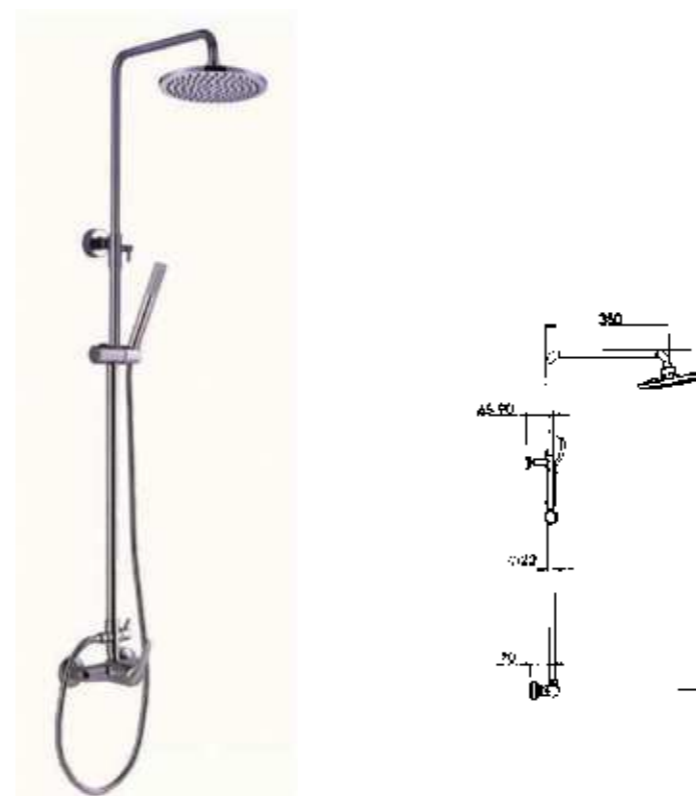

## MEDIUM Set de ducha (columna, rociador cuadrado o redondo, barra y equipo)

Shower set with equipment | Set de douche colonne, avec équipement  
 ОДНОРЫЧАЖНЫЙ НАБОР ДЛЯ ДУША. Включает колонну, верхний душ квадратный/круглый, ручной душ, гибкий шланг

Ref. DX33834C  
 DX33835R  
 Color ●  
 ●



Columna Telescópica  
 Telescopic columns  
 Colonne télescopiques  
 Teleskopische Säulen  
 Комплект встраиваемого

ECO Set de ducha (columna, rociador cuadrado o redondo, barra y equipo)

Shower set with equipment | Set de douche colonne, avec équipement  
 ОДНОРЫЧАЖНЫЙ ЭКОЛОГИЧЕСКИЙ НАБОР ДЛЯ ДУША. Включает  
 колонну, верхний душ квадратный\круглый, ручной душ, гибкий шланг

Ref. Color

DXE33835R ●

DXE33834C ●



# HOTELES & COLECTIVIDADES



MARTÍ 1921 lleva innovando nuevas líneas y productos para la industria hotelera y médico sanitaria, desarrollando nuevos sistemas ECOEFICIENTES de ahorro de agua y energía, seguridad, salud y confort para los usuarios.

Durante todo este tiempo, MARTÍ 1921 ha perfeccionado sus sistemas de producción, como consecuencia de las específicas exigencias y normativas sanitarias que garantizan que los materiales en contacto con el agua no suponen ningún riesgo para la salud.

*Martí 1921 has been innovating new lines and products for the hotels industry, medical and sanitary, developing new ECO- EFFICIENT systems, of water and energy savings, safety, health and comfort for the users.*

*During this time, MARTI has perfected its production systems, as a result of specific of sanitary regulations, to ensure that the materials in contact with water don't suppose any risk for the health.*



## ECOSYSTEM | ECOSYSTEM

Resistencia en el recorrido de la palanca del grifo monomando para suministrar el 50% del caudal. Incorpora un sencillo dispositivo de dos posiciones en la palanca que permite diferenciar entre la zona de caudal económico y caudal máximo. Al levantar la palanca para obtener más caudal, un tope elástico ofrece una ligera resistencia y advierte que se pasa a la zona de máximo caudal logrando así un ahorro de agua. El usuario puede superar esta limitación abriendo el grifo a su caudal máximo. Viene montado desde fábrica y no requiere ningún mantenimiento. (Opcional)

*Resistance in the path of the mixer tap lever, to supply 50% of the flow rate. It incorporates a simple device of two positions on the lever that allow to differentiate between the economic flow range and the maximum flow. By lifting the lever for more flow, an elastic top offers a slight resistance and warns that passes near maximum flow, this way achieving water savings. The user can overcome this limitation by opening the faucet to its maximum flow. It comes installed from factory and requires no maintenance. (Optional)*



## LIMITACIÓN DE TEMPERATURA | TEMPERATURE LIMITATION

Sistema limitador de temperatura del agua caliente que indica al usuario el límite de temperatura de uso eficiente (38-42°C), consiguiendo así un ahorro energético y evitando quemaduras.

*A temperature limitation system for the hot water, that indicates the user the limit of the temperature, for an efficient use (38- 42°C), achieving energy savings, and avoiding burnings.*



## LIMITACIÓN DE CAUDAL | LIMITATION OF THE WATER FLOW

Sistemas de limitación de caudal de forma eficiente que permiten reducir el consumo de agua manteniendo el confort de uso. Los aireadores mezclan aire y agua para reducir el consumo de agua y evitar salpicaduras. MARTÍ 1921 desde 1995 innovando y aplicando soluciones ecoeficientes.

*Flow limitation systems that reduce water consumption, while maintaining wearing comfort. The aerators mix air and water in order to reduce water consumption and avoid splashing. Since 1995, Martí 1921 has been innovating and applying efficient solutions.*

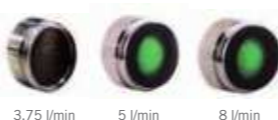

UTILIZACIÓN/USE	LIMITACIÓN/LIMITER	AHORRO/SAVING
DUCHA/ SHOWER	8 Litros	33%
	6 Litros	50%
LAVABO/TAP MIXER	5 Litros	50%
	3,5 Litros	70%
	8 Litros	33%



## BLOQUEO DE SEGURIDAD | TERMOSTOP BLOCK

Dispositivo que permite limitar la temperatura de agua caliente (<38°C) según el nivel de seguridad deseado bloqueando el recorrido de la palanca del monomando. Evita el riesgo de quemaduras así como el consumo excesivo de agua caliente. El usuario debe pulsar el botón y girar el volante para obtener temperaturas superiores. (Opcional)

*Device that allows the blocking of the hot water temperature (<38°C), according to the desired security level, by blocking the circuit of the handle. It avoids the burning risks, as well as the excessive use of hot water. The user must press the button and move the lever, in order to get higher temperatures. (Optional)*



## SANITARIA/MÉDICA | SANITARY/ MEDICAL

Toda la grifería MARTÍ 1921 supera las exigencias normativas sanitarias de KTW (Alemania), WRAS (Reino Unido) y ACS (Francia), que garantizan que los materiales en contacto con el agua no suponen ningún riesgo para la salud.

*All MARTI mixers exceed regulatory requirements of health KTW (Germany), WRAS (UK) and ACS (France), that ensure that the materials in contact with water pose no risk for the health.*



## SENSIBILIDAD | SENSITIVITY

Nuestros cartuchos de monomando y termostáticos permiten regular cómodamente la temperatura deseada.

*Our single- handle mixer and the thermostatic ones, allow the easy adjust of the desired temperature.*



## ANTILEGIONELA | ANTILEGIONELA

MARTÍ 1921 dispone de diversos sistemas que evitan la proliferación de la legionela, siguiendo los sistemas aplicados en la normativa española y francesa.

*Martí disposes of different systems that avoid the growth of the Legionella, according to the systems applied in the French and Spanish legislation.*



## CROMOTERAPIA | CHROMOTHERAPY

La cromoterapia es un método de armonización y ayuda natural al equilibrio del cuerpo y la mente por medio de los colores en nuestra ducha diaria.

*The chromotherapy is a way of harmonizing the balance of the body and mind, by using colors, in our everyday shower.*



## REDUCCIÓN DE SONIDO | SOUND REDUCTION

Las griferías MARTÍ 1921 disponen de varios sistemas de protección acústica que permiten superar la normativa europea que exige no sobrepasar los 30dB. Nuestras excéntricas de conexión van equipadas con un elemento reductor de ruido (silenciador), al igual que los cartuchos cerámicos. Disponemos de diferentes filtros acústicos tanto en las entradas de agua de los grifos como en el interior de sus mecanismos de regulación. (Opcionales)

*Martí mixers dispose of several systems of acoustic protection, that allow overcome the European norms, that require not to exceed the limit of 30Db. Our connection cams, as well as the ceramic cartridges, are equipped with noise reducing element (silencer). We have different acoustic filters, both at the water inputs, and inside of their regulatory system. (Optional)*

# Hoteles y colectividades



## DURABILIDAD Y ROBUSTEZ | DURABILITY AND STRENGTH

Los productos MARTI 1921, están avalados por un siglo de experiencia industrial. Técnicamente innovadores en soluciones técnicas y diseño, aportan además gran robustez para soportar todo tipo de uso, incluso el mas intensivo. Gracias a unos exigentes procedimientos certificados ISO 9001/2008 podemos garantizar el completo proceso de fabricación y la fiabilidad que aportan para su uso publico.

Para certificar la calidad del acabado se realizan pruebas en cámaras de niebla salina, superando la norma EN 817. MARTI 1921, en base a los continuos estudios realizados en conjunto con la firma KH LLOREDA y los laboratorios especializados en investigación metalúrgica, certifica que la calidad de sus recubrimientos galvánicos es óptima.

De los análisis realizados en conjunto con KH LLOREDA, MARTI 1921 recomienda el uso de los productos de esta firma para el mantenimiento de sus acabados.

*The MARTI 1921 products are backed up by a century of industrial experience. Technically innovative in technical solutions and design, also provide great strength to withstand all types of use, including the most intensives. Thanks to one of the most demanding procedures certified by ISO 9001/2008, we can guarantee the entire manufacturing process and reliability provided for public use.*

*To certify the quality of the coatings, the tests are performed in salt spray chambers, exceeding EN 817. MARTI 1921. In base of the ongoing studies realized along with the KH LLOREDA company and laboratories specialized in metallurgical research, certifies that the quality of their galvanic coatings is optimal.*

*After the analyzes performed along with KH LLOREDA, MARTI 1921 recommends the use of their the products for the maintenance of their coatings.*



## Personalización

### PERSONALIZATION

Martí ofrece a sus clientes la posibilidad de personalizar sus productos grabando en láser su logotipo.

*Martí offers its clients the possibility of personalizing the products, by laser marking their logotype.*



## ALGUNOS ESTABLECIMIENTOS EQUIPADOS CON MARTÍ 1921 | SOME ESTABLISHMENTS EQUIPPED WITH MARTÍ 1921

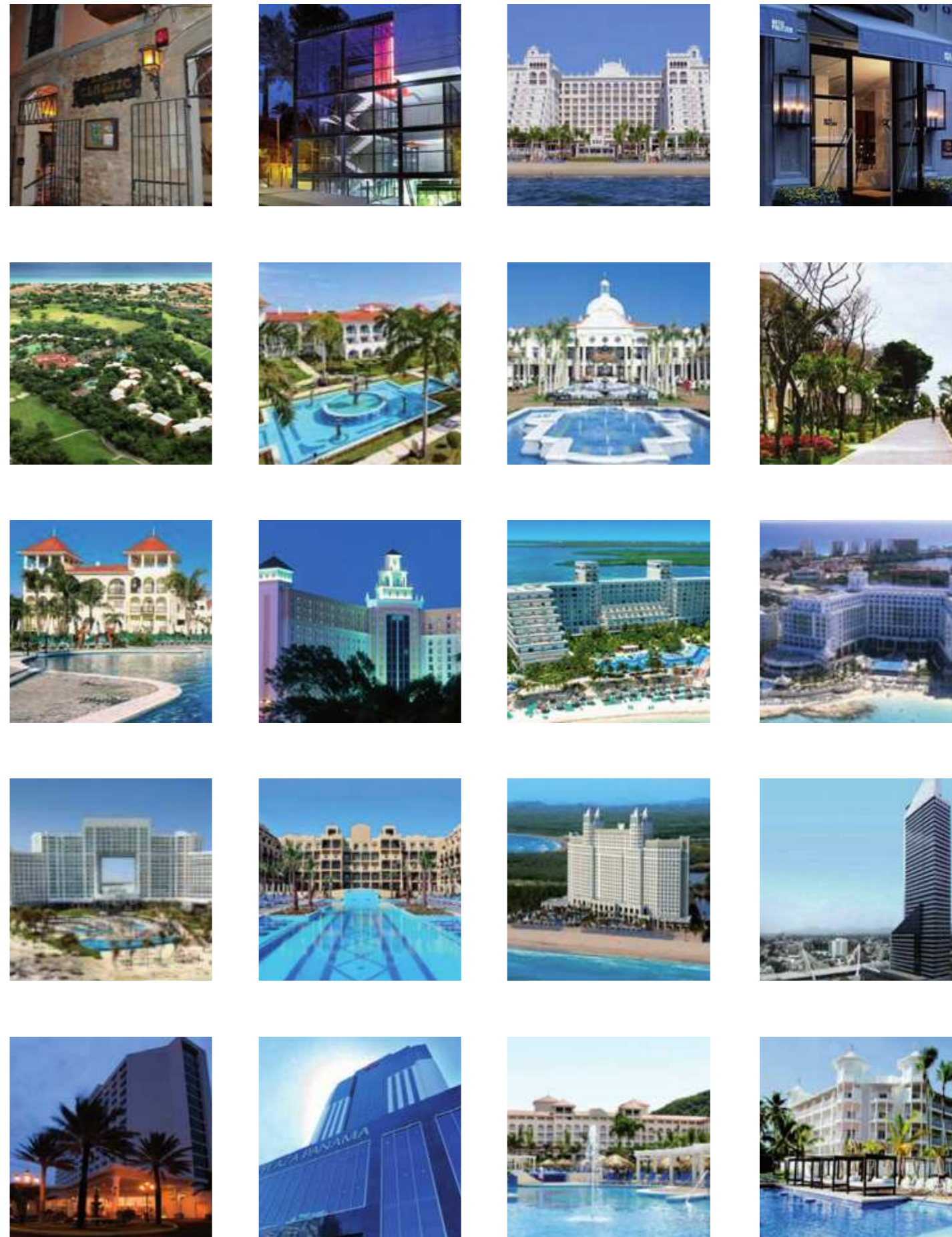

# Hoteles y colectividades

## THE ONE HT Monomando lavabo

Wash-basin mixer | Mitigeur lavabo | Einhebel waschtischmischer  
Однорычажный Смеситель для раковины

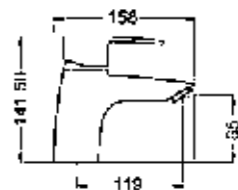

Ref. Color

133101HT ●

133102HT *cv* ●

*c/v: válvula clic clac*

\* Cartucho due.  
Aireador anticalcáreo con  
limitador de caudal 8l/minuto.  
Fijación inoxidable

## THE ONE HT Monomando lavabo empotrado

Built-in single-lever wash-basin mixer | Mitigeur lavabo mural à encastrer  
Unterputz Einhebel wannenmischer | Однорычажный Смеситель для раковины встроенный

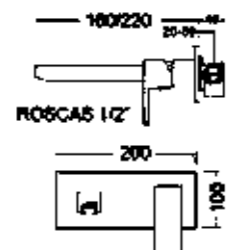

Ref. Color

138108HT ●

\* Cartucho due.

## THE ONE HT Monomando bidé

Bidet mixer | Mitigeur bidet | Einhebel bidetmischer | Однорычажный Смеситель для Биде

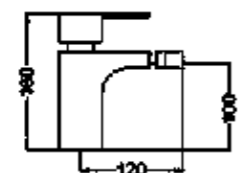

Ref. Color

133201HT ●

133202HT *cv* ●

*c/v: válvula clic clac*

\* Cartucho due.  
Aireador anticalcáreo con  
limitador de caudal 8l/minuto.  
Fijación inoxidable.

## THE ONE HT Monomando empotrado para bidé/wc

Built-in bidet mixer wc | Mitigeur bidet/wc à encastrer  
Set messing unterputz-mischer mit handbrause  
Однорычажный смеситель для биде, встраиваемый



Ref. Color

132515HT ●

\* Cartucho due.

## THE ONE HT Monomando ducha con accesorios

Shower mixer with accessories | Mitigeur douche avec accessoires  
Einhebel duschmischer mit Zubehör | Однорычажный Смеситель для душа с аксессуарами

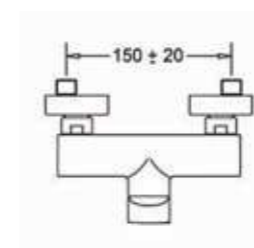

Ref. Color

133401HT ●

\* Flexo antibacteriano.

## THE ONE HT Monomando empotrado ducha

Built-in shower mixer | Mitigeur douche à encastrer  
Unterputz duschmischer | Однорычажный Смеситель встроенный для душа

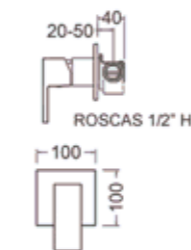

Ref. Color

132415HT ●

\* Resistencia a golpe de ariete superior a 100KI/cm<sup>2</sup>

## THE ONE HT Monomando empotrado baño ducha

Built-in bath/shower mixer | Mitigeur bain-douche à encastrer  
Unterputz wannen und duschmischer | Однорычажный Смеситель встроенный ванна душ

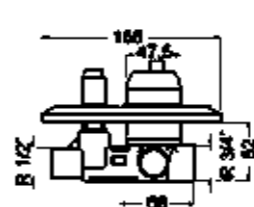

Ref. Color

132414HT ●

\* Resistencia a golpe de ariete superior a 100KI/cm<sup>2</sup>

## THE ONE HT Monomando baño ducha con accesorios

Bath/shower mixer with accessories | Mitigeur bain-douche avec accessoires  
Einhebel wannen und duschmischer mit Zubehör  
Однорычажный Смеситель для ванны и душа с аксессуарами

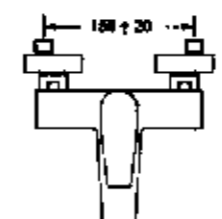

Ref. Color

13301HT ●

\* Flexo antibacteriano.  
Desviador metálico resistente a la tracción.  
Aireador anticalcáreo gran caudal.

## THE ONE HT Kit monomando ducha empotrado

Kit Built-in shower | Kit Mitigeur douche a encastrer | Kit Unterputz duschmischer  
Комплект встраиваемого однорычажного душа

Ref. Color

KT1301HT ●

\* Resistencia a golpe de ariete superior a 100KI/cm<sup>2</sup>

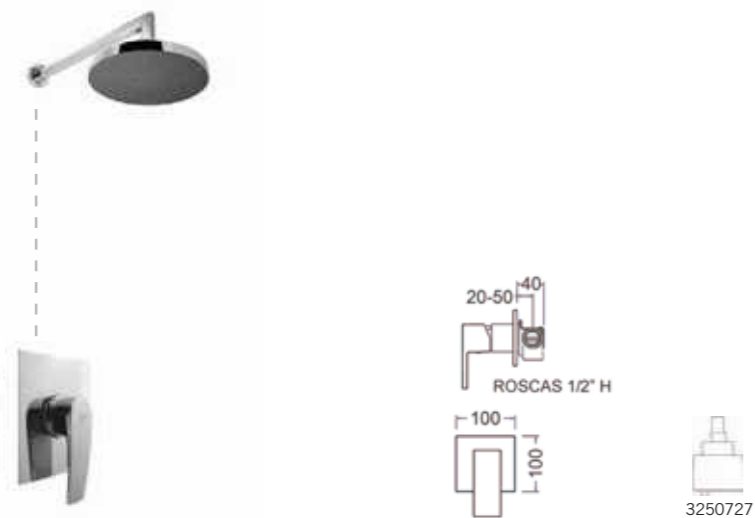

## THE ONE Kit monomando ducha empotrado dos funciones

Kit Built-in shower with two functions  
Kit Mitigeur douche a encastrer avec deux fonction | Kit Brausebatterie, zwei Funktionen  
Комплект встраиваемого однорычажного душа (две функции)

Ref. Color

KT1303HT ●

\* Resistencia a golpe de ariete superior a 100Kg/cm<sup>2</sup>

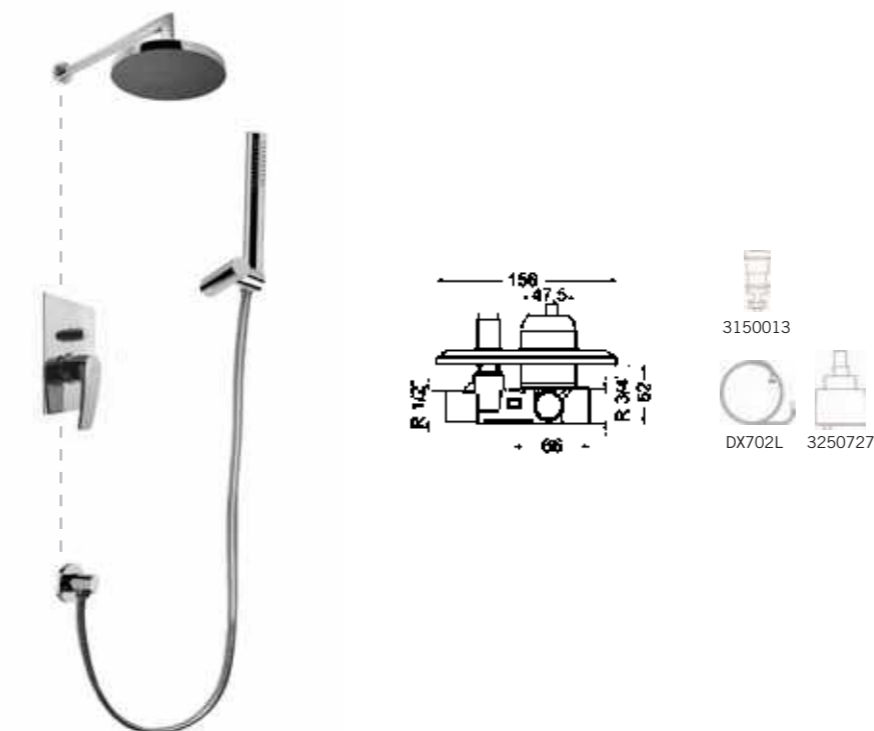

## THE ONE HT Kit monomando ducha empotrado dos funciones

Kit Built-in shower with two functions  
Kit Mitigeur douche a encastrer avec deux fonction | Kit Brausebatterie, zwei Funktionen  
Комплект встраиваемого однорычажного душа (две функции)

Ref. Color

KT1302HT ●

\* Resistencia a golpe de ariete superior a 100KI/cm<sup>2</sup>

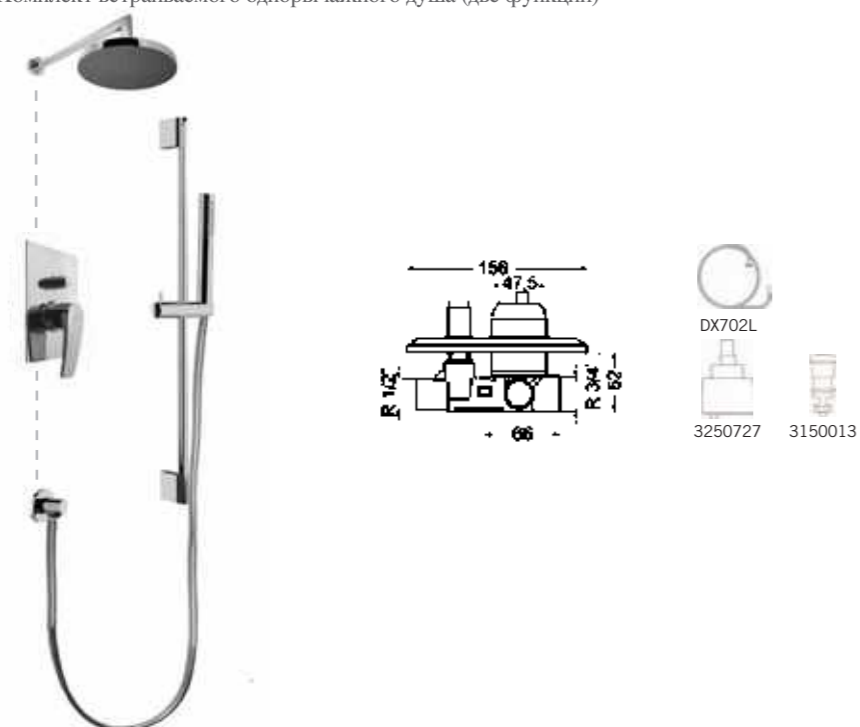

# Hoteles y colectividades

## SENA HT Monomando lavabo

Wash-basin mixer | Mitigeur lavabo | Einhebel waschtischmischer  
Однорычажный Смеситель для раковины

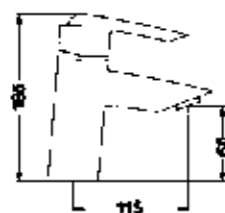

Ref. Color

868101HT ●

868102HT *cv* ●

*cv*: válvula clic clac

\* Cartucho due.  
Aireador anticalcáreo con  
limitador de caudal 8l/minuto.  
Fijación inoxidable

## SENA HT Monomando bidé

Bidet mixer | Mitigeur bidet | Einhebel bidetmischer | Однорычажный Смеситель для Биде

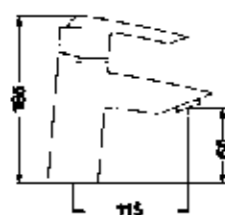

Ref. Color

868201HT ●

868202HT *cv* ●

*cv*: válvula clic clac

\* Cartucho due.  
Aireador anticalcáreo con  
limitador de caudal 8l/minutos.  
Fijación inoxidable.

## SENA HT Monomando ducha con accesorios

Shower mixer with accessories | Mitigeur douche avec accessoires  
Einhebel duschmischer mit Zubehör | Однорычажный Смеситель для душа с аксессуарами

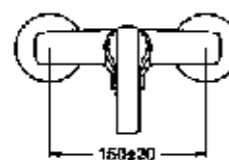

Ref. Color

868401HT ●

\* Flexo antibacteriano.  
Desviador metálico resistente a la tracción.  
Aireador anticalcáreo gran caudal.

## SENA HT Monomando empotrado ducha

Built-in shower mixer | Mitigeur douche à encastrer  
Unterputz duschmischer | Однорычажный Смеситель встроенный для душа

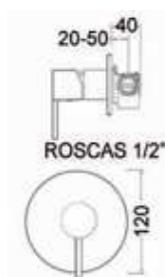

Ref. Color

862415HT ●

\* Resistencia a golpe de ariete  
superior a 100Kl/cm<sup>2</sup>

## SENA HT Monomando baño ducha con accesorios

Bath/shower mixer with accessories | Mitigeur bain-douche avec accessoires  
Einhebel wannen und duschmischer mit Zubehör  
Однорычажный Смеситель для ванны и душа с аксессуарами

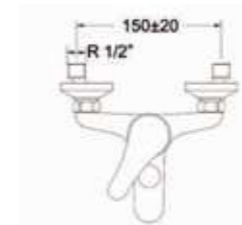

Ref. Color

868301HT ●

\* Flexo antibacteriano.  
Desviador metálico resistente a la tracción.  
Aireador anticalcáreo gran caudal.

## SENA HT Monomando empotrado baño ducha

Built-in bath/shower mixer | Mitigeur bain-douche à encastrer  
Unterputz wannen und duschmischer | Однорычажный Смеситель встроенный ванна душ

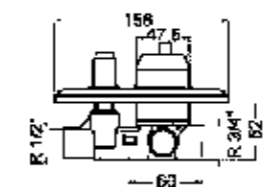

Ref. Color

862414HT ●

\* Resistencia a golpe de ariete  
superior a 100Kl/cm<sup>2</sup>





# Hoteles y colectividades

## AKTIVA HT Monomando lavabo

Wash-basin mixer | Mitigeur lavabo | Einhebel waschtischmischer  
Однорычажный Смеситель для раковины

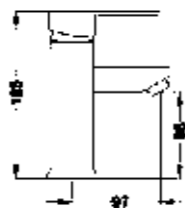

Ref. Color

848101HT ●

848102HT *cv* ●

*cv*: válvula clic clac

\* Cartucho due.  
Aireador anticalcáreo con  
limitador de caudal 8l/minuto.  
Fijación inoxidable

## AKTIVA HT Monomando lavabo alto

High wash-basin mixer | Mitigeur lavabo haut | Einhebel waschtischmischer. Hohemn ausführung  
Однорычажный Смеситель для раковин высокий

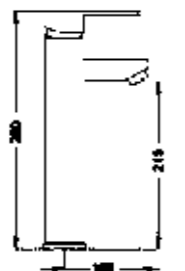

Ref. Color

848111HT ●

848112HT *cv* ●

*cv*: válvula clic clac

\* Cartucho due.  
Aireador anticalcáreo con  
limitador de caudal 8l/minuto.  
Fijación inoxidable.

## AKTIVA HT Monomando bidé

Bidet mixer | Mitigeur bidet | Einhebel bidetmischer | Однорычажный Смеситель для Биде

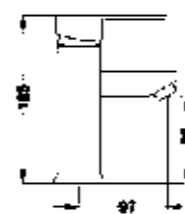

Ref. Color

848201HT ●

848202HT *cv* ●

*cv*: válvula clic clac

\* Cartucho due.  
Aireador anticalcáreo con  
limitador de caudal 8l/minuto.  
Fijación inoxidable.

## AKTIVA HT Monomando ducha con accesorios

Shower mixer with accessories | Mitigeur douche avec accessoires  
Einhebel duschmischer mit Zubehör  
Однорычажный Смеситель для ванны и душа с аксессуарами

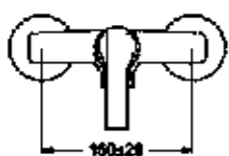

Ref. Color

848401HT ●

\* Flexo antibacteriano.

## AKTIVA HT Monomando empotrado ducha

Built-in shower mixer | Mitigeur douche à encastrer  
Unterputz duschmischer | Однорычажный Смеситель встроенный для душа



Ref. Color

842415HT ●

\* Resistencia a golpe de ariete superior a 100Km/cm<sup>2</sup>

## AKTIVA HT Monomando baño ducha con accesorios

Bath/shower mixer with accessories | Mitigeur bain-douche avec accessoires  
Einhebel wannen und duschmischer mit Zubehör  
Однорычажный Смеситель для ванны и душа с аксессуарами

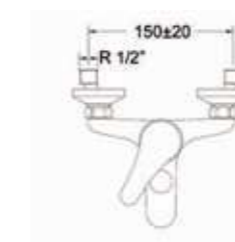

Ref. Color

848301HT ●

\* Flexo antibacteriano.  
Desviador metálico resistente a la tracción.  
Aireador anticalcáreo gran caudal.

## AKTIVA HT Monomando empotrar baño ducha

Built-in bath/shower mixer | Mitigeur bain-douche à encastrer  
Unterputz wannen und duschmischer | Однорычажный Смеситель встроенный ванна душ

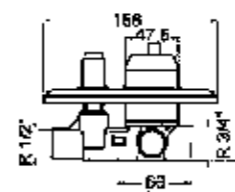

Ref. Color

842414HT ●

\* Resistencia a golpe de ariete superior a 100KI/cm<sup>2</sup>



## MÉXICO HT Set de ducha monomando o termostática

Shower set with equipment | Set de douche colonne, avec équipement  
Однорычажный или термостатический набор для душа

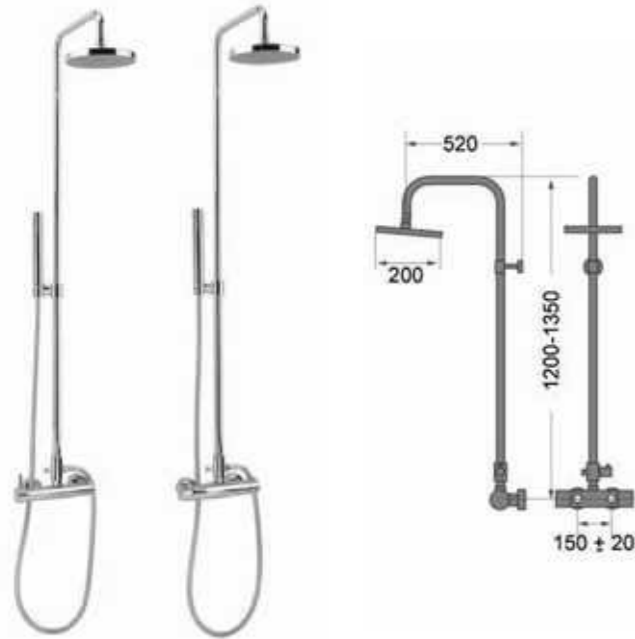

Ref.	Color
TEO104GHT	●
TEO104GMHT	●

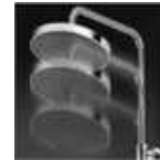

Columna Telescópica  
Telescopic columns  
Colonnes télescopiques  
Teleskopische Säulen  
Комплект встраиваемого

\* Resistencia a golpe de ariete superior a 100Kl/cm<sup>2</sup>

## JAMAICA HT Set de ducha monomando o termostática

Shower set with equipment | Set de douche colonne, avec équipement  
Однорычажный или термостатический набор для душа



Ref.	Color
TEO104CHT	●
TEO104CMHT	●

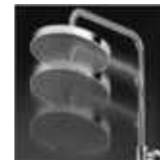

Columna Telescópica  
Telescopic columns  
Colonnes télescopiques  
Teleskopische Säulen  
Комплект встраиваемого

\* Resistencia a golpe de ariete superior a 100Kl/cm<sup>2</sup>



## Aireador M24 con limitador de caudal 3 l/min

Ref.	Color
31590073L	●

Aerator M24 for cast spouts with 3 l/min flow limiter  
Аэратор м24 с ограничением 3л/мин



## Aireador M24 con limitador de caudal 5 l/min

Ref.	Color
31590075L	●

Aerator M24 for cast spouts with 5 l/min flow limiter  
Аэратор м24 с ограничением 5л/мин



## Aireador M24 con limitador de caudal 8 l/min

Ref.	Color
31590078L	●

Aerator M24 for cast spouts with 8 l/min flow limiter  
Аэратор м24 с ограничением 8л/мин



## Junta de 1/2 limitadora de caudal a 3, 6 y 8 litros

Ref.	Color
31590013L	-
31590016L	-
31590018L	-

1/2 Membrane limiter for 6 l/min  
Аэратор м24 с ограничением 3л/мин



## DUE Cartucho eco 2 posiciones de apertura: 60% - 100% CAUDAL 35Ø - 40Ø

Ref.	Color
13250753-35 S/F	-
23250752-35 S/L	-
13250753-40 S/F	-
23250754-40 S/L	-

DUE Eco cartridges 2 opening steps: 60% - 100% FLOW  
Двойной картридж экологический, 2 вида открытия: 60% 100%



S/L: Salida libre  
S/F: Salida fija



## COLD Cartucho eco apertura de agua fría 35Ø - 40Ø

Ref.	Color	PVP
13250755-35 S/F	-	12,00€
23250756-35 S/L	-	12,00€
13250757-40 S/F	-	12,00€
23250758-40 S/L	-	12,00€

COLD Eco cartridges opening cold water  
Экологический картридж открывающий холодную воду

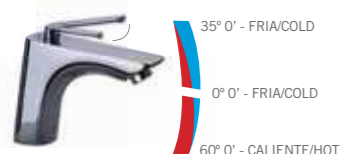

S/L: Salida libre  
S/F: Salida fija



## COLD - DUE Cartucho eco 40Ø - 35Ø

Ref.	Color
13250759-35 S/F	-
23250760-35 S/L	-
13250761-40 S/F	-
23250762-40 S/L	-

COLD - DUE Eco cartridges | двойной экологический картридж

COLD - Apertura de agua fría con el consiguiente ahorro de energía.  
Opening movement in cold water, saving energy.

DUE - Apertura en 2 posiciones, posibilitando el ahorro de agua (menor caudal).  
Two steps opening movement, saving by less water flow.

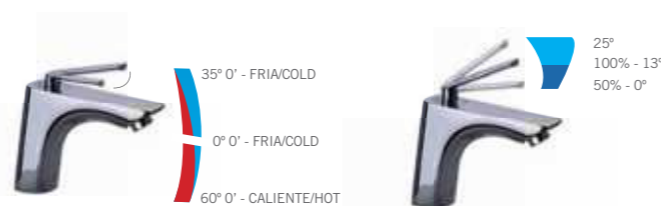

S/L: Salida libre  
S/F: Salida fija



## Cartucho termoequilibrado 40Ø Salida libre

Ref.	Color
13250763E S/L	-
23250763 40 S/L	-

Pressure balance cartridge | картридж

Opción de entrega de fábrica con límite de temperatura programado.  
2 Termoequilibrado

Posibility og delivery with temperature limit programed.  
2 Pressure balance

Este cartucho en un cuerpo ideal mantiene la temperatura constante escogida por el usuario.

Debido a que tiene un sistema específico que compensa las variaciones de presión tanto de agua fría como en agua caliente. Actúa con la precisión de un equipo termostático, pero sin problemas de envejecimiento.

Due an specific mechanism that compensate the potential pressure balances variations. This cartridge in an ideal faucet, keeps the selected temperature constant, either if the pressure difference comes from the cold or hot water. It operates with the precision of a thermostatic equipment, but without the aging problems.

S/L: Salida libre  
S/F: Salida fija



## Cartucho de gran caudal a baja presión 40Ø

Ref.	Color	PVP
3250764-40 S/F	-	13,00€
13250765-40 S/L	-	13,00€

High flow cartridge at low pressure  
картридж с большим напором

100% compatible con cartucho estandar 40mm.  
100% compatible with 40mm standart carbridge

S/L: Salida libre  
S/F: Salida fija

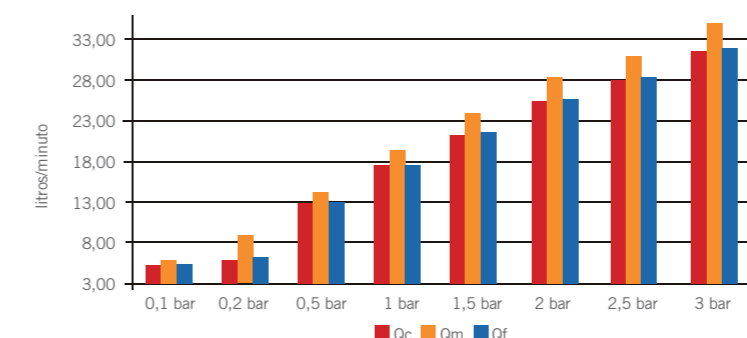

## Cartucho regulador de temperatura y caudal 35Ø - 40Ø

Cartridge with temperature and water-flow regulator  
Картридж температурный с регулятором воды

### REGULADOR DEL CAUDAL - FLOW/RATE REGULATOR (3 bar)

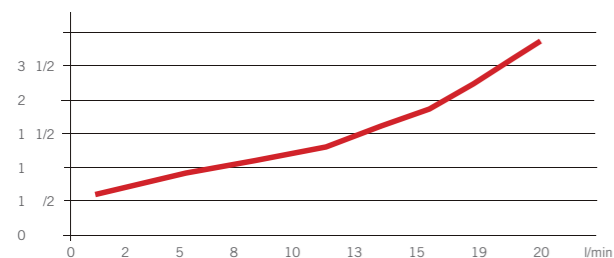

### REGULADOR DEL AGUA CALIENTE - HOT WATER REGULATOR

POS	AGUA FRÍA COLD WATER l/min. 15°C	AGUA CALIENTE HOT WATER l/min. 65°C	°C 3 bar
7	16	4	26°
6	12,5	7,5	35°
5	9	11	43°
4	5	15	50°
3	2	18	56°
2	1	19	61°
1	0	20	65°

Ref.	Color
3250766-35 S/F	-
3250767-35 S/L	-
3250768-40 S/F	-
3250769-40 S/L	-

S/L: Salida libre  
S/F: Salida fija



## Excéntrica con filtro y cierre incorporado M 1/2 x H 3/4 especial termostáticas

Eccentric with filter and special incorporated closing for thermostatic  
Excentrique avec filtre et une fermeture incorporée spéciale pour thermostatiques | Эксцентрик с фильтром и ключом, специально для термостатов

## Tele ducha anticalcárea extra plana

Antilime shower head plea sure  
Douchette anticalcaire | Ручной душ

## Tele ducha anticalcáreo

Antilime shower head  
Douchette anticalcaire  
Ручной душ анти известковый

## Teleducha anticalcáreo 3 posiciones

Antilime shower head 3 positions  
Douchette anticalcaire 3 positions  
Ручной душ с 3 функциями

Ref.	Color
EX0002	-
DX101R	●
DX103C	●
DX110R	●



## Flexo 1,70 silver plate

Hose 1,70 silver plate  
Tuyau 1,70 silver plate  
Гибкий шланг

## Toma de agua redonda 1/2" M x 1/2" M

Round water connection  
Prise d'eau arrondie  
Круглый подвод воды

## Toma de agua cuadrada 1/2" M x 1/2" M

Square water connection  
Prise d'eau carré  
Квадратный подвод воды

## Flexo doble engatillado extensible 1'70 a 2'20 cm máxima resistencia

Reinforced hose 1'70 - 2'20 cm extensible maximum resistance  
Tuyau renforcé 1'70 a 2'20 cm extensible resistance maximate

## Rociador ducha anticalcáreo carcasa ABS mecanismo interno alta presión

Antilime shower head framework and high pressure internal mechanism  
Pomme de tête anticalcaire, carcasse ABS avec un mecanisme interne de haute pression  
Верхний душ

Martí 1921 recomienda para su correcto mantenimiento

## Rociador ducha anticalcárea 220x200mm

Antilime shower head framework and high pressure internal mechanism  
Pomme de tête anticalcaire, carcasse ABS avec un mecanisme interne de haute pression  
Верхний душ антиизвестковый 220x200мм

Martí 1921 recomienda para su correcto mantenimiento

## Barra deslizante latón cuadrada 70mm

Square sliding bar brass  
Barre de douche carré laiton  
Стойка для душа

Ref.	Color
DX701S	●
DX402R	●
DX401C	●
DX702L	●
DX001/200RG	●
DX002/200GC	●
DX202C	●



## Barra deslizante latón 610mm

Brass sliding bar  
Barre de douche laiton

Ref.

DX203R

Color



## Brazo de ducha a pared cuadrado 350 mm

Square shower arm at wall | Bras de douche carré a mur  
Держатель для верхнего душа для установки на стене, квадратный 350 мм

Ref.

DX502C

Color



## Brazo de ducha a pared redondo 370 mm

Cylindrical shower arm at wall | Bras de douche rond a mur  
Держатель для верхнего душа для установки на стене, круглый 370 мм

Ref.

DX503R

Color



## Caño redondo 18 cm

Round spout | Bec rond  
Стойка для душа

Ref.

DX607

Color



## Caño cuadrado 18 cm

Suare spout | Bec carré  
Стойка для душа

Ref.

DX605

Color

-



## Caño redondo con inversor 18 cm

Round spout with divert | Bec rond avec distributeur  
Стойка для душа

Ref.

DX606

Color



## Caño cuadrado con inversor 18 cm

Square spout with divert | Bec carré avec distributeur  
Стойка для душа

Ref.

DX604

Color



## Espejo a pared

Wall mounted mirror | Miroir au mur  
Зеркало

Ref.

AM0101

Color



AM0101OR



## Espejo empotrado

Concealed mirror | Miroir encastré  
Настенное зеркало

Ref.

AM0102

Color



## Espejo a pared

Wall mounted mirror | Miroir au mur  
Настенное зеркало

Ref.





AM0103

Color



## Asidero 20 cm





Handle | Poignée  
Держатель 20 см

Ref.	Color
AM0009	
AM0009BR	
AM0009RU	
AM0009OR	



## Asidero 30cm





Handle | Poignée  
Держатель 30 см

Ref.	Color
AM0006	
AM0006BR	
AM0006RU	
AM0006OR	



## Asidero 40cm





Handle | Poignée  
Держатель 40 см

Ref.	Color
AM0008	
AM0008BR	
AM0008RU	
AM0008OR	



## Asidero 45 cm





Handle | Poignée  
Держатель 45 см

Ref.	Color
AM0003	
AM0003BR	
AM0003RU	
AM0003OR	



## Asidero curvo 41cm





Curved handle | poignée incurvée  
Держатель крыглыйй 41 см

Ref.	Color
AM0005	
AM0005BR	
AM0005RU	
AM0005OR	



## Toallero simple 60cm





Simple towel rack | Porte-serviettes simple  
Вешалка 60 см

Ref.	Color
AM0026	
AM0026BR	
AM0026RU	
AM0026OR	



## Toallero de ducha 60cm





Shower towel rack | Porte-serviette pour la douche  
Вешалка 60 см

Ref.	Color
AM0004	
AM0004BR	
AM0004RU	
AM0004OR	



## Portarrollos





Roll holder | Porte-papier hygiénique  
Держатель туалетной бумаги

Ref.	Color
AM0027	
AM0027BR	
AM0027RU	
AM0027OR	



## Portarrollos doble





Double roll holder | Porte-papier hygiénique double  
Двойной держатель туалетной бумаги

Ref.	Color
AM0028	
AM0028BR	
AM0028RU	
AM0028OR	



## Portarrollos vertical





Vertical roll holder | Porte-papier hygiénique vertical  
Крючок

Ref.	Color
AM0001	
AM0001BR	
AM0001RU	
AM0001OR	



## Percha





Hanger | Crochet  
Крючок

Ref.	Color
AM0002	
AM0002BR	
AM0002RU	
AM0002OR	



## Percha

Hanger | Crochet  
Крючок

Ref.	Color
AM0025	
AM0025BR	
AM0025RU	
AM0025OR	



# COMPLEMENTOS Y RECAMBIOS



# COMPLEMENTOS

## Rociador con cascada en resina a pared textura lisa

	Ref.	Color
Wall shower head and waterfall made resine	SPE008500BL	○
Pomme de tête avec cascade a mur fait en resine	SPE008500NG	●
Распылитель с функцией дождевого душа и каскада, поверхность гладкая		



## Rociador con cascada en resina a pared textura pizarra

	Ref.	Color
Wall shower head and waterfall made resine	SPE008501BL	○
Pomme de tête avec cascade a mur fait en resine	SPE008501NG	●
Распылитель с функцией дождевого душа и каскада, рельефная поверхность		



## Rociador en resina a pared textura lisa

	Ref.	Color
Wall shower head made resine	SPE008800BL	○
Pomme de tête a mur fait en resine	SPE008800NG	●
Распылитель с функцией дождевого душа и каскада, поверхность гладкая		



## Rociador en resina a pared textura pizarra

	Ref.	Color
Wall shower head made resine	SPE008801BL	○
Pomme de tête a mur fait en resine	SPE008801NG	●
Распылитель с функцией дождевого душа и каскада, рельефная поверхность		



## Rociador ducha a techo en acero inox 420x420mm

	Ref.	Color
Ceiling stainless steel shower head	SPE044096	●
Pomme de tête acier inoxydable à toit		
Распылитель с функцией дождевого душа и каскада, нержавеющая сталь, 420x420мм		



## Rociador ducha antical ABS 220x200mm

	Ref.	Color
Antilime shower head	SPE0440099	●
Pomme de tête anticalcaire		
Верхний душ антиизвестковый 220x200мм		



## Rociador ducha antical ABS 200

	Ref.	Color
Wall shower head made resine	DX001/200E	●
Pomme de tête a mur fait en resine		
Верхний душ антиизвестковый		



## Rociador ducha anticalcáreo carcasa ABS mecanismo interno alta presión

	Ref.	Color
Antilime shower head framework and high pressure internal mechanism	DX001/200RG	●
Pomme de tête anticalcaire, carcasse ABS avec un mecanisme interne de haute pression		
Верхний душ круглый		



## Rociador ducha anticalcáreo ABS

	Ref.	Color
Brass square Siphon	DX001/200R	●
Siphon en laiton carré	DX001/250R	●
Верхний душ антиизвестковый круглый	DX001/300R	●



## Rociador ducha antical extraplano 20 cm

	Ref.	Color
Antilime shower head stainless steel	DX001/200RL	●
Pomme de tête anticalcaire acier inoxydable		
Верхний душ анти известковый супер тонкий 25 см		

NEW



## Rociador ducha antical extraplano 200x200

	Ref.	Color
Antilime shower head stainless steel	DX002/200CD	●
Pomme de tête anticalcaire acier inoxydable		

NEW



## Rociador ducha antical extraplano 300x300

	Ref.	Color
Antilime shower head stainless steel	DX002/300CD	●
Pomme de tête anticalcaire acier inoxydable		

NEW



## Rociador ducha antical extraplano 400x400

	Ref.	Color
Antilime shower head stainless steel	DX002/400CD	●
Pomme de tête anticalcaire acier inoxydable		

NEW



## Rociador ducha anticalcáreo acero inox.

	Ref.	Color
Antilime shower head stainless steel	DX001/400R	●
Pomme de tête anticalcaire acier inoxydable	DX001/500C	●
Верхний душ анти известковый, нержавеющая сталь		





# COMPLEMENTOS

## Rociador ducha anticalcáreo ABS 200x200mm

Antilime shower head  
Pomme de tête anticalcaire  
Верхний душ анти известковый 220x200мм, квадратный

Ref. DX002/200E  
Color ●



## Rociador ducha anticalcária 220x200mm

Antilime shower head  
Pomme de tête anticalcaire  
Верхний душ анти известковый 200x200мм, квадратный

Ref. DX002/200GC  
Color ●



## Rociador ducha anticalcáreo ABS

Antilime shower head  
Pomme de tête anticalcaire  
Верхний душ анти известковый, квадратный

Ref. DX002/200C  
Color ●  
DX002/300C ●



## Rociador ducha anticalcáreo acero inox.

Antilime shower head stainless steel  
Pomme de tête anticalcaire acier inoxydable  
Верхний душ анти известковый, нержавеющей сталь

Ref. DX002/400C  
Color ●  
DX002/500C ●



## Rociador 20cms Retro cromo latón

Pomme de tête  
Shower head  
Верхний душ 20 см серии Ретро

Ref. DX0016  
Color ●



## Rociador 15cms Retro cromo latón

Pomme de tête  
Shower head  
Верхний душ 15cm серии Ретро

Ref. DX0017  
Color ●



## Caño redondo 18 cm - R 1/2"

Round spout | Bec rond  
Стойка для душа

NEW

Ref. DX607  
Color ●



## Caño cuadrado 18 cm - R 1/2"

Suare spout | Bec carré  
Стойка для душа

NEW

Ref. DX605  
Color -



## Caño redondo con inversor 18 cm - R 1/2"

Round spout with divert | Bec rond avec distributeur  
Стойка для душа

NEW

Ref. DX606  
Color ●



## Caño cuadrado con inversor 18 cm - R 1/2"

Square spout with divert | Bec carré avec distributeur  
Стойка для душа

NEW

Ref. DX604  
Color ●



## Brazo de ducha a techo cuadrado 200 mm

Square arm shower at ceiling  
Bras de douche carré à toit  
Держатель для верхнего душа, квадратный 200 мм

Ref. DX502VC  
Color ●



## Brazo de ducha a techo redondo 200 mm

Cylindrical arm shower at ceiling  
Bras rond de douche à toit  
Держатель для верхнего душа, круглый 200 мм

Ref. DX503VR  
Color ●



## Brazo de ducha a pared cuadrado 350 mm

Square shower arm at wall  
Bras de douche carré a mur  
Держатель для верхнего душа, квадратный 350 мм

Ref. DX502C  
Color ●



## Brazo de ducha a pared redondo 370 mm

Cylindrical shower arm at wall  
Bras de douche rond a mur  
Держатель для верхнего душа, круглый 370 мм

Ref. DX503R  
Color ●



# COMPLEMENTOS

## Brazo de ducha a pared redondo EKO 430 mm

Cylindrical shower arm at wall Eko  
Bras de douche rond a mur Eko  
Держатель для верхнего душа, экологический, квадратный 430 мм

Ref.

DX503E

Color



## Jet empotrar antical 1/2"

Wall mounted Jet antilime  
Jet anticalcaire à encastrer

Ref.

SPE044091

Color



## Jet empotrar antical 1/2"

Wall mounted Jet antilime  
Jet anticalcaire à encastrer  
Боковая форсунка для душа

Ref.

O090R

Color



## Jet cuadrado lateral antical 1/2"

Square lateral Jet antilime  
Jet carrè latéral anticalcaire  
Боковая квадратная форсунка для душа

Ref.

CM099C

Color



## Jet redondo lateral antical 1/2"

Cylindrical lateral Jet antilime  
Jet rond latéral anticalcaire  
Боковая круглая форсунка для душа

Ref.

O099R

Color



## Barra deslizante latón cuadrada 70 cm

Square sliding bar brass  
Barre de douche carré laiton  
Стойка для душа квадратная 70 CM

Ref.

DX202C

Color



## Barra deslizante latón 70 cm

Brass sliding bar  
Barre de douche laiton  
Стойка для душа, латунь, 70 см

Ref.

DX205R

Color



## Barra deslizante latón 610 mm

Brass sliding bar  
Barre de douche laiton  
Стойка для душа, латунь, 610 мм

Ref.

DX203R

Color



## Barra deslizante latón eco 610 mm

Eco sliding bar  
Barre de douche Eco  
Стойка для душа, экологическая, латунь, 610 мм

Ref.

DX208R

Color



## Tele ducha anticalcárea extra plana

Antilime shower head plea sure  
Douchette anticalcaire  
Ручной душ, анти известковый

Ref.

DX101R

Color



## Tele ducha anticalcáreo

Antilime shower head  
Douchette anticalcaire  
Ручной душ, анти известковый

Ref.

DX103C

Color



## Tele ducha anticalcáreo Granada

Antilime shower head Granada  
Douchette anticalcaire Granada  
Ручной душ, анти известковый Гранада

Ref.

DX104R

Color



## Tele ducha anticalcáreo CC1

Antilime shower head CC1  
Douchette anticalcaire CC1  
Ручной душ, анти известковый CC1

Ref.

DX105R

Color



## Tele ducha anticalcáreo

Antilime shower head  
Douchette anticalcaire  
Ручной душ, анти известковый

Ref.

DX106R

Color



## Tele ducha anticalcáreo

Antilime shower head  
Douchette anticalcaire  
Ручной душ, анти известковый

Ref. DX108R  
Color ●



## Tele ducha anticalcáreo Rialto

Antilime shower head Rialto  
Douchette anticalcaire Rialto  
Ручной душ, анти известковый Риалто

Ref. DX109R  
Color ●



## Teleducha anticalcáreo 3 posiciones

Antilime shower head 3 positions  
Douchette anticalcaire 3 positions  
Ручной душ 3 функции, анти известковый

Ref. DX110R  
Color ●



## Teleducha 1921

1921 handshower  
Douchette 1921  
Ручной душ 1921

Ref. 3170448  
Color ●  
3170448BR ●  
3170448CO ●  
3170448PL ●  
3170448RU ●  
3170448OR ●



## Teleducha para extraíble Avant

Avant pull over handshower  
Douchette para extraível Avant  
Ручной душ Авант

Ref. 716CR  
Color ●



## Teleducha para extraíble Astor, CC1, CC2

Astor, CC1, CC2 pull over handshower  
Douchette para extraível Astor, CC1, CC2  
Ручной душ для моделей Астор, CC1, CC2

Ref. 717CR  
Color ●



## Ducha WC/Bide

Shower toilet  
Douche WC  
Ручной душ для биде

Ref. DX0085  
Color ●



## Soporte 1921

1921 stand  
Support 1921  
Держатель ручного душа подвижный 1921

Ref. 3180470  
Color ●  
3180470CO ●  
3180470BR ●  
3180470PL ●  
3180470RU ●  
3180470OR ●



## Soporte cuadrado orientable

Adjustable square stand  
Support carré orientable  
Держатель ручного душа подвижный

Ref. DX302C  
Color ●



## Soporte redondo orientable

Adjustable round stand  
Support rond orientable  
Держатель ручного душа подвижный

Ref. DX303R  
Color ●



## Soporte orientable eco ducha

Adjustable stand Eco shower  
Support orientable douchette Eco  
Держатель ручного душа подвижный, экологический

Ref. DX304E  
Color ●



## Toma de agua cuadrada 1/2" M x 1/2" M

Square water connection  
Prise d'eau carré  
Подвод воды настенный, квадратный

Ref. DX401C  
Color ●



## Toma de agua redonda 1/2" M x 1/2" M

Round water connection  
Prise d'eau arrondie  
Подвод воды настенный, круглый, для гибкого шланга

Ref. DX402R  
Color ●



## Toma de agua cuadrada con soporte orientable 1/2" M x 1/2" M

Square water connection with adjustable stand  
Prise d'eau carré avec support orientable  
Квадратный настенный держатель для ручного душа с подводом

Ref. DX401SC  
Color ●



## Toma de agua ECO 1/2" M x 1/2" H

Water connection Eco  
Prise d'eau Eco  
Подвод воды настенный, для гибкого шланга

Ref. DX402E  
Color ●



## Toma de agua redonda soporte orientable 1/2" M X 1/2" H

Round water connection with adjustable stand  
Prise d'eau avec support orientable  
Круглый настенный держатель для ручного душа с подводом

Ref. DX402SC  
Color ●



## Válvula clic clac universal tapón cuadrado

Clic Clac universal valve with square stopper  
Clic-Clac valve universal avec bouchon carré  
Донный клапан без перелива

Ref. DX801C  
Color ●



## Válvula clic clac universal tapon redondo

Clic Clac valve with round stopper  
Clic-Clac valve avec bouchon  
Донный клапан с переливом

Ref. DX802R ●  
DX802RBR ●  
DX802RCCO ●  
DX802RRU ●  
DX802RROR ●



## Válvula clic clac universal básica

Basic clic clac basic universal valve  
Clic clac valve universal basiqueEco  
Донный клапан

Ref. DX803E  
Color ●



## Válvula desagüe plato de ducha

Shower Valve  
Vidage pour le plateaux sanitaire de douche  
слив для поддона

Ref. DX810R  
Color ●



## Válvula Clic clac desagüe bañera con rebosadero

Clic clac bath waste with overflow  
Clic clac baignoire avec déversoir  
донный клапан для ванной с клик клак

Ref. DX820R  
Color ●



## Válvula desagüe

Pop up waste mounted with cylindric head  
Vanne automatique avec corps cylindrique  
Донный клапан независимый

Ref. DX804R ●  
DX804A\* ●

\*Válvula desagüe americana  
Pop up americaine waste



## Válvula bañera con llenador

Bath valve with spout  
Vidage puor baignoire avec bec  
Слив-перелив для ванны

Ref. DX821R  
Color ●



## Sifón redondo latón

Brass square Siphon  
Siphon en laiton carré  
Сифон в виде бутылки для раковины

Ref. DX902R  
Color ●



## Sifón cuadrado latón

Brass square Siphon  
Siphon en laiton carré  
Сифон в виде бутылки для раковины

Ref. DX901C  
Color ●



## Alargaderas baño 6cms

Bath extensions 6cms  
Extension baignoire 6cm  
набор перепускных вентилей

Ref. 5200 ●  
5200BR ●  
5200RU ●



# COMPLEMENTOS

Juego columnas s/bañera	Ref.	Color
Set of coumn for bath Jeu de colonnes sur baignoire Стойки, набор для установки смесителей на ванну	350CR	●



Llave de regulación cuadrada 1/2"	Ref.	Color
Clic Clac universal valve with square stopper Clic-Clac valve universal avec bouchon carré ключ регулировки 1/2, квадратный	DX911C	●



Llave de regulación redonda 1/2"	Ref.	Color
Wall mounted round faucet Robinet d'arrêt ronde ключ регулировки 1/2, круглый	DX912R	●



Llave de paso 1/2" x 1/2"	Ref.	Color
Stopcock 1/2" x 1/2" Robinet d'arrêt 1/2" x 1/2" задвижной кран 1/2x1/2, перепускной вентиль с разборным фильтром	DX950R	●



Flexo 1,70 silver plate	Ref.	Color
Hose 1,70 silver plate Tuyau 1,70 silver plate душевой шланг 1,70	DX701S	●



Extraíble fregadero VI4003	Ref.	Color
Industrial handshower VI4003 Douchette industrielle VI4003 съёмный кран для мойки	3170452	●



Extraíble fregadero VI4025	Ref.	Color
Industrial handshower VI4025 Douchette industrielle VI4025 съёмный кран для мойки	3170456	●



Flexo 1,2mt para extraíble cocina cromo Avant	Ref.	Color
Hose 1,2mt for pull over sink mixer crome Avant Tuyau 1,2mt pour cuisine chrome amovible Avant шланг 1,2 м для съёмных кухонных смесителей, хромированный, Авант	69	●



Flexo 1,2mt para extraíble	Ref.	Color
Hose for pull over VI3103 Tuyau pour VI3103 amovible шланг съёмный для держателя	70NE	●



Flexo doble engatillado extensible 1,70 a 2,20 máxima resistencia	Ref.	Color
Reinforced hose 1,70 a 2,20 extensible maximun resistance Tuyau renforcé 1,70 a 2,20 extensible resistance maximale Гибкий шланг с двойным швом и системой анти скручивания, от 1,70 до 2,20 с высоким сопротивлением	DX702L	●
	DX702LCO	●
	DX702LBR	●
	DX702LPL	●
	DX702LRU	●
DX702LOR	●	



Flexo 1,2mt toilet con aireador	Ref.	Color
Hose with aerator Tuyau avec aérateur гибкий туалетный шланг с аэратором	DX703C	●
	DX703CBR	●
	DX703CRU	●
	DX703COR	●



Excéntrica con filtro M 1/2 x M 3/4, especial termostáticas	Ref.	Color
Excentrics with filter M1/2 x M 3/4 special for thermostatics Excentrique avec filtre M1/2 x M 3/4 special thermostatique Эксцентрик с фильтром, специально для термостатов	EX0002	●



Bolsa lana limpiadora de cromados	Ref.	Color
Chromed wool cleaner bag Cromé sac de nettoyant de laine мешочек с муфтой для установки смесителя	00481337LC	-





## Aireador 18 interno

Aerator 18  
Aérateur 18  
аэратор 18 внутренний

Ref.

3159017

Color



## Aireador H18

Aerator H18  
Aérateur H18  
аэратор H18

Ref.

3179212

Color



## Aireador M18 Loft/Granada

Aerator M18 Loft/Granada  
Aérateur H18 Loft/Granada  
Аэратор м18 лофт/гранادا

Ref.

3159014

Color



## Aireador H22

Aerator H22  
Aérateur H22  
аэратор H22

Ref.

3159008

Color



## Aireador H22 cilíndrico

Aerator H22  
Aérateur H22  
аэратор H22 цилиндрический

Ref.

3159010

Color



## Aireador M24

Aerator M24  
Aérateur M24  
аэратор M24

Ref.

3159007

Color



3159007BR



3159007RU



## Aireador M28

Aerator M28  
Aérateur M28  
аэратор M28

Ref.

3159006

Color



## Rótula + Aireador 22x24

Joint ball + Aerator 22x24  
Rotule + Aérateur 22x24  
соединительный шар + аэратор 22x24

Ref.	Color
3159027	●
3159027BR	●
3159027RU	●



## Rotula + Aireador 18

Joint ball + Aerator 18  
Rotule + Aérateur 18  
соединительный шар + аэратор 18

Ref.	Color
3159028	●
3159028BR	●
3159028RU	●



## Rótula + Aireador 22x22

Joint ball + Aerator 22x22  
Rotule + Aérateur 22x22  
соединительный шар + аэратор 22x22

Ref.	Color
3159030	●
3159030BR	●
3159030RU	●



## Aireador osmosis

Aerator osmosis  
Aérateur osmosis  
аэратор Osmosis

Ref.	Color
3159035	●



## Bolsa sujeción lavabo Concept con pié

Fixing bag for Concept mixer with base  
Sac de fixation pour lavabo Concept avec pied  
механизм крепления

Ref.	Color
KIT 004	●



## Bolsa sujeción Standar

Fixing bag for Standar  
Sac de fixation pour Standar  
механизм крепления

Ref.	Color
KIT 0012	●



## Bolsa sujeción con dos espárragos métricos

Fixing bag for  
Sac de fixation pour  
механизм крепления

Ref.	Color
KIT 0014	●



## Cartucho 25

Cartridge 25  
Cartouche 25  
картридж 25

Ref.	Color
3250723	-



## Cartucho 25

Cartridge 25  
Cartouche 25  
картридж 25

Ref.	Color
3250732	-



## Cartucho 25 S/L.

Cartridge 25 S/L.  
Cartouche 25 S/L.  
картридж 25 с/л

Ref.	Color
3250734	-



## Cartucho 25 Altair

Altair cartridge 25  
Cartouche 25 Altair  
картридж 25 серии Altair

Ref.	Color
3250739	-



## Cartucho 25 SUP

Cartridge 25  
Cartouche 25  
картридж 25 sup

Ref.	Color
3250741	-



## Cartucho progresivo 35 S/L.

Progressive cartridge 35 F/L.  
Cartouche progressive 35 S/L.  
прогрессивный картридж 35 с/л

Ref.	Color
3250719	-



## Cartucho 35 S/L.

Cartridge 35 S/L.  
Cartouche 35 S/L.  
картридж 35 с/л

Ref.	Color
3250725	-



## Cartucho progresivo 35 S/F.

Progressive cartridge 35 S/S.  
Cartouche progressive 35 S/F.  
прогрессивный картридж 35 с/с

Ref. Color

3250726 -



## Cartucho 35 S/F.

Cartridge 35 F/S.  
Cartouche 35 S/F.

Ref. Color

3250727 -



## Cartucho 38 S/F.

Cartridge 38 S/F.  
Cartouche 38 S/F.  
прогрессивный картридж 38 с/с

Ref. Color

3250738 -



## Cartucho 40 S/L.

Cartridge 40 S/L.  
Cartouche 40 S/L.  
картридж 40 с/л

Ref. Color

3250724 -



## Cartucho 40 S/F.

Cartridge 40 S/S.  
Cartouche 40 S/F.  
картридж 40 с/с

Ref. Color

3250729 -



## Cartucho joystick 35 S/F. MRT2

Joystick cartridge 35 S/F. MRT2  
Cartouche joystick 35 S/F. MRT2  
картридж джойстик 35 с/с MRT2

Ref. Color

3250743 -



## Cartucho joystick 35 S/F.

Joystick cartridge 35 S/F.  
Cartouche joystick 35 S/F.  
картридж джойстик 35 с/с

Ref. Color

3250742 -



## Cartucho termostático Retro

Retro thermostatic cartridge  
Cartouche thermostatique Retro  
термостатический картридж Retro

Ref. Color

3250735 -



## Cartucho termostático Thermarlux

Thermarlux thermostatic cartridge  
Cartouche thermostatique Thermarlux  
термостатический картридж Thermalux

Ref. Color

3250736 -



## Cartucho termostático Minima Term.

Minima Term. thermostatic cartridge  
Cartouche thermostatique MinimaTerm  
термостатический картридж Minima Term

Ref. Color

3250737 -



## Cartucho termostático SW711

SW711 thermostatic cartridge  
Cartouche thermostatique SW711  
термостатический картридж SW711

Ref. Color

3250746 -



## Cartucho termostático CT1118

CT1118 thermostatic cartridge  
Cartouche thermostatique CT1118  
термостатический картридж

Ref. Color

3250771 -



## Cartucho termostático CTM118

CTM118 thermostatic cartridge  
Cartouche thermostatique CTM118  
термостатический картридж

Ref. Color

3250772 -



## Cartucho termostático CT6118

CT6118 thermostatic cartridge  
Cartouche thermostatique CT6118  
термостатический картридж

Ref. Color

3250773 -





## Montura cerámica 22 der.

22 ceramic headwork  
Monture en céramique 22  
керамический кран-букс, 22 правый

Ref. Color

3240706 -



## Montura cerámica 22 izq.

22 ceramic headwork  
Monture en céramique 22  
керамический кран-букс, 22 правый

Ref. Color

3240707 -



## Montura cerámica 26 der..

26 ceramic headwork  
Monture en céramique 26  
керамический кран букс, 26 правый

Ref. Color

3240708 -



## Montura convencional

Headwork  
керамический кран букс

Ref. Color

3240714 -



## Inversor baño ducha latón 61mm

Bath shower divert 61mm  
Inverseur de baignoire douche lation 61mm  
инверсор ванна душ, латунь 61 мм

Ref. Color

3150006 ●



## Inversor baño ducha 3512/3514

Bath shower divert 3512/3514  
Inverseur de baignoire douche 3512/3514  
инверсор ванна душ 3512/3514

Ref. Color

3150033 -



## Inversor baño ducha Rialto

Rialto bath shower divert  
Inverseur de baignoire douche Rialto  
инверсор ванна душ RIALTO

Ref. Color

3150035 -



## Inversor baño ducha Rodano

Rodano bath shower divert  
Inverseur de baignoire douche Rodano  
инверсор ванна душ RODANO

Ref. Color

3150023 -



## Inversor baño ducha Algora

Algora bath shower divert  
Inverseur de baignoire douche Algora  
инверсор ванна душ ALGORA

Ref. Color

3150022 -



## Inversor baño ducha Compac L.

Compac L bath shower divert  
Inverseur de baignoire douche Compac L  
инверсор ванна душ COMPAC L

Ref. Color

3150024 -



## Inversor baño ducha Compact

Compact bath shower divert  
Inverseur de baignoire douche Compact  
инверсор ванна душ COMPACT

Ref. Color

3150012 -



## Inversor baño ducha Granada

Granada bath shower divert  
Inverseur de baignoire douche Granada  
инверсор ванна душ GRANADA

Ref. Color

3150025 -



## Inversor baño ducha emp.

Bath shower divert emp.  
Inverseur de baignoire douche emp.  
инверсор ванна душ встроенный

Ref. Color

3150013 -



## Inversor baño ducha term.

Term. bath shower divert  
Inverseur de baignoire douche term.  
инверсор ванна душ термостатический

Ref. Color

3150026 -



Inversor baño ducha MRT1	Ref.	Color
MRT1 bath shower divert Inverseur de baignoire douche MRT1 инверсор ванна душ MRT1	3150031	-



Latiguillo 15cms. extraible cocina	Ref.	Color
Flexible pressure hose 15cms. for pull over sink mixer Tuyaux de 15cm. pour cuisine amovible шланг выдвигной для кухонного смесителя 15 см	0001	●



Juego latiguillos 35cms. B larga T.3/8"	Ref.	Color
Set of flexible pressure 35cms. B larga T.3/8" Jeu de tuyaux de 35cm. B larga T.3/8" комплект шлангов, длина 35 см с подключением 3/8	0002	●



Juego latiguillos 50/60cms. T.3/8"	Ref.	Color
Set of flexible pressure 50/60cms. T.3/8" Jeu de tuyaux de 50/60cm. T.3/8" Комплект шлангов, длина 50/60 см с подключением 3/8	0004	●



Florón exc. Retro diam. 80mm	Ref.	Color
Flange diam. 80mm Rosace 80mm Шайба декоративная Retro, диаметр 80 мм	0001ONCR	●
	0001ONBR	●
	0001ONRU	●



Florón exc. Simphony diam. 70mm	Ref.	Color
Simphony flange diam. 70mm Rosace Simphony 70mm Шайба декоративная Simphony, диаметр 70 мм	000254CR	●



Florón exc. Concept diam. 64mm	Ref.	Color
Concept flange diam. 64mm Rosace Concept 64mm Шайба декоративная Concept, диаметр 64 мм	0003CO	●



Florón exc. Rialto diam. 64mm	Ref.	Color
Rialto flange diam. 64mm Rosace Rialto 64mm Шайба декоративная Rialto, диаметр 64 мм	0004RI	●



Florón emp. baño ducha diam. 155mm	Ref.	Color
Flange for Concealed bath shower diam. 155mm Rosace mural baignoire douche 155mm Встроенный шайба декоративная ванна душ, диаметр 155 мм	0005EM	●



Florón emp. ducha diam.int. 51,5mm	Ref.	Color
Flange for Concealed shower diam.in. 51,5mm Rosace mural douche 51,5mm Встроенный шайба декоративная душ, диаметр 51,5 мм	0006EM	●



Florón mndo. 35mm/40mm	Ref.	Color
Single lever flange 35mm/40mm Rosace 35mm/40mm Шайба декоративная 35мм/40мм	35	●
	40	●



Florón emp. ducha diam.int. 45,5mm	Ref.	Color
Flange for Concealed shower diam.in. 45,5mm Rosace mural douche 45,5mm Шайба декоративная 45,5mm	0007EM	●



Asiento	Ref.	Color
Seat Siège Сиденье	51	-



Base mndo/monobloc	Ref.	Color
Single lever base Base mitigeur/monobloc Гайка круглая	1CR	●
	1BR	●
	1CO	●
	1PL	●
	1RU	●



Base Granada	Ref.	Color
Granada base Base Granada Гайка Гранада	2	



Base para refuerzo encimera inox	Ref.	Color
Reinforce base for worktop inox Base de comptoir acier d'armature	8	



Excéntrica 1/2x3/4 de 50mm.c/silenciador	Ref.	Color
Eccentric 1/2x3/4 of 50mm with silencer Eccentrique 1/2x3/4 de 50mm avec silencieux Патрубок эксцентричный	EX0001	-



Silenciador	Ref.	Color
Silencer Silencieux Вставка противозвучная	3100041	



Maneta Granada	Ref.	Color
Granada handle Levier Granada Ручка Granada	334	



Maneta Gerontológica	Ref.	Color
Gerontology handle Levier gérontologique Ручка Gerontológica	337	









Maneta Rialto	Ref.	Color
Rialto handle Levier Rialto Ручка Rialto	341	



Maneta Symphony	Ref.	Color
Symphony handle Levier Symphony Ручка Symphony	360	
	360CO	
	360BR	



Maneta Willy	Ref.	Color
Willy handle Levier Willy Ручка Willy	363CN	
	363CB	
	363CL	
	363CR	
	363NA	
	363CP	
	363CH	
	363CA	
	363OR	
	363SA	
	363CF	





Maneta Arte	Ref.	Color
Arte handle Levier Arte Ручка Arte	363	



Maneta CC1	Ref.	Color
CC1 handle Levier CC1 Ручка CC1	364	



Maneta Loft	Ref.	Color
Loft handle Levier Loft Ручка Loft	366	
	366BR	
	366RU	



Maneta Altair	Ref.	Color
Altair handle Levier Altair Ручка Altair	AT0001	
	AT0001BC	
	AT0001NC	



## Maneta Cubic 25mm/35mm

Cubic 25mm/35mm handle  
Levier Cubic 25mm/35mm  
Ручка Cubic 25мм/35мм

Ref.	Color
372	●
373	●



## Maneta Barroco porcelana

Barroco handle porcelain  
Levier Barroco porcelaine  
Ручка керамическая Барроко

Ref.	Color
48347	●
48347CR	●
48347BR	●
48347RU	●



## Maneta Majestic porcelana

Majestic handle porcelain  
Levier Majestic porcelaine  
Ручка керамическая Majestic

Ref.	Color
09346	●
09346CR	●
09346BR	●
09346RU	●



## Maneta O2 lavabo-bidé

O2 handle for bidet-basin mixer  
Levier O2 lavabo-bidet  
Ручка O2 смеситель-биде

Ref.	Color
370	●
370NE	●
370BL	○



## Maneta O2 baño-ducha

O2 handle for bath-shower mixer  
Levier O2 baignoire-douche  
Ручка O2 ванна душ

Ref.	Color
371	●
371NE	●
371BL	○



## Maneta Platinum lavabo-bidé

Platinum handle for bidet-basin mixer  
Levier Platinum lavabo-bidet  
Ручка Platinum смеситель-биде

Ref.	Color
PL0001	●



## Maneta Platinum baño-ducha

Platinum handle for bath-shower mixer  
Levier Platinum baignoire-douche  
Ручка Platinum ванна душ

Ref.	Color
PL0002	●



## Volante Paris

Handle Paris  
Poignée Paris  
Ручка Paris

Ref.	Color
11CR	●



## Volante 192, Sixtina

Handle 1921, Sixtina  
Poignée 1921, Sixtina  
Ручка 192, Sixtina

Ref.	Color
14CR	●
14BR	●
14CO	●
14RU	●



## Indice bicolor

Two colorate indexes  
Index bicolor  
индикатор

Ref.	Color
34	-



## Indice 8mm

Index 8mm  
Index 8mm  
индикатор 8мм

Ref.	Color
34CR	-



# SHOWROOM & EXPOSITORES



Ref. 564 Expositor 70x40x190 cm



Ref. 563 Expositor para 4 grifos  
(Alt. Encimera) 40x36x88 cm



Ref. 580 Expositor Sets de ducha  
60x52x140 cm



# CONDICIONES GENERALES DE VENTA

General sale conditions

*Martí*  
1921  
barcelona

# CONDICIONES GENERALES DE VENTA

## 1. Generalidades

Las ventas y suministros a efectuar por Acsa Bath Solutions Comercial, S.L. (en adelante Acsabath), y la recepción de un pedido por parte del comprador, en España, suponen la aceptación de estas condiciones generales de venta, excepto aquello que expresamente acordado, en distinta forma en oferta, o en la aceptación de pedido, constituya condición particular. Por ello, no tendrán valor cualesquiera condiciones no aceptadas explícitamente por Acsabath.

## 2. Pedidos

Para la tramitación de cualquier pedido será indispensable que el comprador remita directamente, o a través de nuestro delegado de zona, por escrito, el correspondiente pedido, indicando claramente la referencia Acsabath, descripción, con mención expresa del acabado, nombre de serie y cantidad.

El pedido mínimo aceptable será de un importe no inferior a 150€. Para cantidades inferiores, el comprador acepta que nuestros almacenes agrupen diferentes pedidos hasta alcanzar la cifra de pedido mínimo.

## 3. Precios

Los precios incluidos en nuestra tarifa están expresados en €. Son precios venta público sugerido. No contemplan impuestos, que deberán sumarse al tipo y modalidad que especifique la legislación en vigor.

Acsabath, en función de los incrementos que puedan sufrir la materia prima u otros conceptos, se reserva el derecho a modificar las tarifas, lo que será comunicado fehacientemente por medio de correo electrónico, telefax, etc., o cualquier otra vía usual de comunicación.

## 4. Condiciones de pago

En cumplimiento a la nueva Ley de Plazos de Pago 15/2010, en lo que corresponde a los plazos de pago de las operaciones comerciales, entrega de mercancías o prestación de servicios, les detallamos las condiciones de pago establecidas por dicha Ley:

A partir del 1 de Enero de 2013: 60 días de la fecha de factura.

Descuento por pronto pago o pago anticipado se concederá el 2% exclusivamente a las facturas que se cobren mediante recibo domiciliado, con vencimiento a 20 días fecha de factura. Cualquier otro medio de pago, excluye la opción de aplicación de un descuento por pronto pago.

## 5. Penalizaciones financieras

En el caso de que Acsabath conceda a un cliente como condición explícitamente aceptada, una fórmula de pago que extienda el plazo, este supondrá un recargo del 3% mensual, hasta la fecha de vencimiento.

En caso de impago por devolución de efecto, además de lo que a continuación se especifica, se cargarán los gastos que el banco gestor nos cobre, en cuanto al retraso de envío en documento de pago, variación de vencimiento en documento de pago, o cualquiera manifestación de no cumplimiento de la obligación contractual, automáticamente se cargarán 15 €, más un 3% a partir del día siguiente de producirse la demora.

Sin perjuicio del concepto que el comprador quiera dar a un pago, los que se realicen, se imputarán en primer lugar a las penalizaciones financieras.

Una entidad de seguro de crédito asegura nuestras operaciones comerciales.

## 6. Modificaciones de producto

Acsabath se reserva la facultad de modificar, cancelar o variar cualquiera de sus productos, al objeto siempre de mejorarlos, sin que ello suponga resarcimiento de perjuicio alguno.

## 7. Transporte

Todos los productos viajan por cuenta y riesgo del comprador. Las expediciones iguales o superiores a 600€ viajarán siempre a porte pagado.

Todos los productos con destino a Canarias, Ceuta, Melilla, Andorra, deberán superar 1.000€, para viajar a porte pagado.

Para envíos inferiores a 600€ se cargará un importe fijo en factura de 9€ en concepto de transporte.

Transportes urgentes mediante Courier o agencias diferentes a la habitual, siempre a cargo del comprador.

El comprador comprobará a la recepción de la mercancía el estado de la misma, indicando en el albarán del transportista las posibles incidencias.

Las reclamaciones, si las hubiere, serán efectuadas dentro de los 15 días siguientes a la recepción, rechazándose las efectuadas tras ese plazo.

Todos nuestros envíos viajan acompañados del correspondiente albarán, y listado de contenido electrónico.

## 8. Devoluciones

No se aceptara ninguna devolución sin la aprobación previa de la dirección comercial de Acsabath, previo dictamen de nuestro servicio

de asistencia técnico/comercial.

Antes de proceder al envío de alguna devolución, enviaremos un boletín numerado, que necesariamente acompañará la expedición.

Las devoluciones serán remitidas a porte pagado.

## 9. Depreciación

**Se aplicarán para toda devolución, las siguientes:**

Producto del mismo ejercicio, 10%

Producto del año anterior, 25%

Producto de dos años, 50%

Producto de + dos años, según valoración peso

## 10. Garantías

Los productos de Acsabath están fabricados observando los más estrictos controles de calidad, debidamente certificados.

En todo caso, Acsabath dispone de un servicio de asistencia técnico/comercial, cuyo cometido es asesorar en las dudas de instalación o ayudar a reparar los problemas más comunes en el uso de la grifería.

Si la disfunción detectada obedece a un fallo productivo, la parte afectada será enviada y sustituida sin cargo.

Para disfrutar del servicio de garantía Acsabath, el grifo deberá estar acompañado de la factura de compra.

La garantía cubre los defectos que puedan ser imputados a la calidad del grifo o sus complementos, en lo relacionado a su acabado o partes mecánicas. Nunca los derivados de mantenimiento deficiente o mal uso.

En caso de avería de partes mecánicas, cubiertas por la garantía, se solicitará a Acsabath el recambio oportuno, que se suministrará sin cargo y a porte pagado.

Cada unidad tiene grabados códigos de trazabilidad, muy útiles para identificar las partes originales, así como la fecha de fabricación. Normalmente, nuestro servicio de asistencia técnico/comercial se lo solicitará antes de remitir recambios.

Las piezas deterioradas por el uso no quedan cubiertas por la garantía, salvo que se demuestre vivió de fabricación.

Una tarjeta individual acompaña cada unidad.

Nuestra garantía cubre únicamente la reposición de material, aceptado por nuestro servicio de asistencia técnico/comercial sin que, en ningún caso, podamos hacernos responsables de daños y perjuicios, que por su defecto haya podido producirse directa o indirectamente.

## 11. Reserva de dominio

La mercancía se entiende propiedad de Acsabath hasta la completa liquidación de las facturas pendientes de pago por parte del comprador.

## 12. Jurisdicciones

La buena fe que preside las relaciones de Acsabath con todos sus clientes, y nuestro deseo de resolver por vía amistosa cualquier divergencia, no hacen pensar en posibles reclamaciones judiciales. Previendo este poco probable caso, las partes se someten a los tribunales de la ciudad de Rubí (Barcelona), con renuncia expresa a cualquier otro fuero.

## 13. Medio ambiente

Nuestro compromiso con el cuidado del medio ambiente viene certificado por OCA, en el cumplimiento de la norma ISO 14.001.

Además, asociados a Ecoembres, participamos en el reciclado de nuestros embalajes.

## 14. Calidades

Nuestro compromiso con la calidad y el cuidado de nuestro producto, en lo relativo a diseño-fabricación-comercialización, viene certificado por OCA en el cumplimiento de la norma ISO, 9001, 2008.



# GENERAL SALE CONDITIONS PRICE LIST

## 1. Generalidades

The sales and supplies to effecting for Acsa Bath commercial Solutions, S.L. (In forward Acsabath), and the receipt of an order on the part of the buyer suppose the acceptance of these sales general conditions, except that one that expressly approved, in different form in offer, or in the acceptance of order, constitutes a particular condition. As it they will not have value any conditions not accepted explicitly by Acsabath.

## 2. Orders

For the processing of any order, it will be indispensable, that the buyer sends a written order by mail or fax, indicating clearly, the reference Acsabath, description of the product, with express mention of the finished one, name of series, and quantity and confirm their proforma.

## 3. Prices

The prices included in our rate, are expressed in €. These are sale prices suggested to the public. They do not contemplate taxes, which will have to be added to the type and modality that specifies the legislation in effect.

Acsabath, depending on the increases that could suffer the raw material or other concepts, saves himself the right to modify the rates, which will be communicated authentically by means of e-mail, fax, etc., or any other usual route of communication.

These prices are in EXW incoterm, the cost of the transport is not included.

## 4. Conditions of payment

This issue is to be consulted with the Export Department and Financial Department of the company.

## 5. Financial penalties

In case Acsabath grants a client as explicitly accepted condition, a formula of payment that extends the term, this one will suppose a monthly surcharge of 3 %, up to the date of maturity.

## 6. Modifications of product

Acsabath, reserves the faculty to modify, to cancel, or to change any of its products, in the object always to improve them, without resorting in any responsibility or indemnification.

## 7. Delivery Time

The orders that are received without indications of date of delivery will understand to be served in the brief term of time of agreement with our possibilities of delivery and being able to be sent in several expeditions unless there is an instruction of delivery. The expedition or delivery times are given for an information purpose to orientation, therefore, any delay or a divided expedition will not be reason for indemnification or any claim.

## 8. Returns

No returns are accepted without the previous approval of the business management of Acsabath, previous opinion of our technical / commercial service of assistance.

The material that displays defects not considered by manufacture will not be admitted in return.

Before proceeding to the sending of some return, we will send a numbered bulletin, which necessarily was accompanying the shipment. The freight for the returns will be paid by the client.

## 9. Depreciation

For all the returns of sanitary faucets that are in perfect conditions, they will have depreciation:

Produced this year: 10%

Produced 1 year previous: 25%

Produced 2 years previous: 50%

Produced more than 2 year previous: According to valuation of the weight.

## 10. Guarantees

The products of Acsabath are made observing the strictest quality controls, due certified.

In any case Acsabath has a technical / commercial service of assistance, which assignment is to advise in the doubts of installation, or in helping to repair the most common problems in the use of the plumbing fixtures.

If detected dysfunction, it obeys a productive failure, the affected part will be sent and replaced without charge.

To enjoy Acsabath's service of guarantee, the faucet will have to be accompanied with the invoice of purchase.

The guarantee covers the faults that could be imputed to the quality of the faucet, or its complements, in related to its finished one, or mechanical parts. The derivatives of deficient maintenance, or badly use can never be covered by the guarantee.

In case of breakdown of mechanical parts, covered by the guarantee, it should be requested to Acsabath, the opportune replace, it will be supply without charge.

Every unit has engraved codes of traceability, very useful to identify the original parts, as well as the date of manufacture. Normally, our technical / commercial service of assistance will request it before sending refills.

The pieces deteriorate by the use will not be covered by the guarantee.

Our guarantee covers only the reinstatement of material, accepted by our technical / commercial service of assistance, without so, we could not make ourselves responsible for damage and prejudice, which for its fault, one could have produced direct, or indirectly.

## 11. Reserve of Property

The goods are property of Acsabath, up to the complete liquidation of the invoices pending on payment on part of the buyer.

## 12. Jurisdiction

The good faith that presides over the relations of Acsa Bath Commercial Solutions Limited Liability Company with all clients and our desire to solve all the divergences by friendly approach, do not make us think like possible judicial claims. However to foresee the consequences of this improbable case, both parts will be submitted to Courts in Rubi with express resignation by any other law.

## 13. Environments

Our commitment with the environmental care comes certified by S.G.S, in the fulfillment of the ISO norm 14.001.

In addition associated to ecoembres, we take part in the recycling of our packaging.

## 14. Quality

Our commitment with the quality and the care of our product, in the relative thing to design – manufacture and marketing, comes certified by S.G.S. in the fulfillment of the ISO norm, 9001, 2008.

